

Performance Parameters 1MD04-021-XX

| Type | ΔT_{max} K | Q_{max} W | I_{max} A | U_{max} V | AC R Ohm | H mm | H2* mm | h mm |
|---------------------|-----------------------|----------------|----------------|----------------|-------------|---------|-----------|---------|
| 1MD04-021-xx (N=21) | | | | | | | | |
| 1MD04-021-03 | 69 | 3.5 | 2.3 | 2.6 | 0.80 | 0.9 | 1.4 | 0.9 |
| 1MD04-021-05 | 71 | 2.2 | 1.5 | | 1.32 | 1.1 | 1.6 | 0.5 |
| 1MD04-021-08 | 72 | 1.4 | 1.0 | | 2.11 | 1.4 | 1.9 | 0.8 |
| 1MD04-021-10 | 72 | 1.1 | 0.8 | | 2.77 | 1.6 | 2.1 | 1.0 |
| 1MD04-021-12 | 72 | 1.0 | 0.7 | | 3.16 | 1.8 | 2.3 | 1.2 |
| 1MD04-021-15 | 72 | 0.8 | 0.5 | | 3.95 | 2.1 | 2.6 | 1.5 |

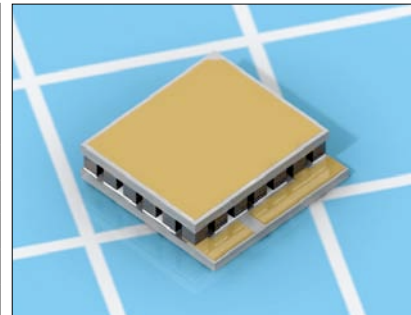

Performance data are given at 300K, vacuum

*Optional H2 value is specified for 0.5mm ceramics thickness

Technical Drawing

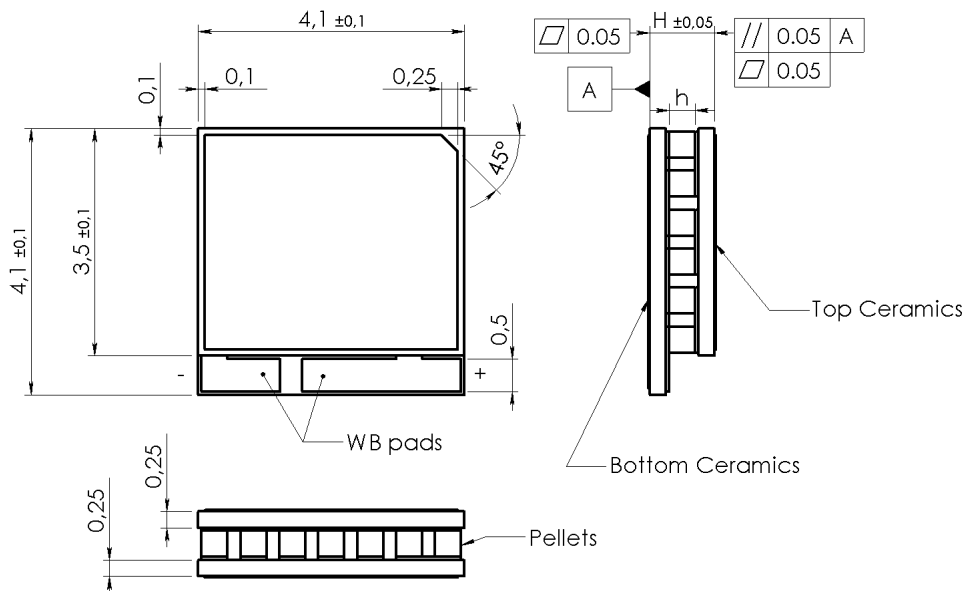

Options available

A. TEC Assembly:

Solder SnSb (Tmelt=230°C)

B. Ceramics:

1. Pure Al₂O₃ (100%)
2. Alumina (Al₂O₃- 96%)
3. Aluminum Nitride (AlN)

100% Al₂O₃ used as standard

C. Ceramics Surface Options

1. Blank ceramics
2. Metallized:
 - 2.1 Ni / Sn(Bi)
 - 2.2 Gold plating
3. Metallized and pre-tinned:
 - 3.1 Solder 94 (PbSnBi, Tmelt=94°C)
 - 3.2 Solder 117 (In-Sn, Tmelt=117°C)
 - 3.3 Solder 138 (Sn-Bi, Tmelt=138°C)
 - 3.4 Solder 183 (Pb-Sn, Tmelt=183°C)

D. Thermistor (optional)

Can be mounted to cold side ceramics edge. Calibration is available.

E. Terminal wires

1. Pre-tinned Copper
2. Insulated Wires
3. Insulated Color Coded
4. Wire Bonding Pads

Performance Plots

1MD04-021-03

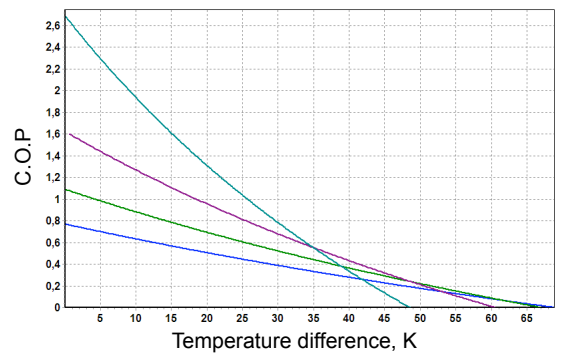
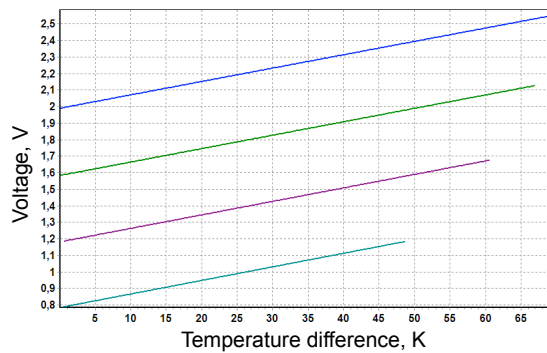
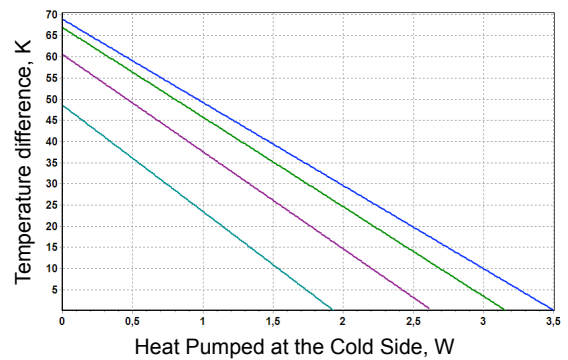
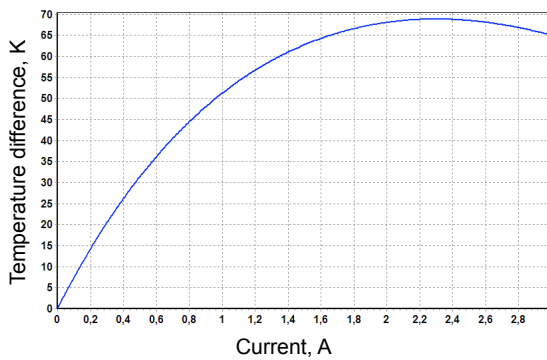

Performance Plots

1MD04-021-05

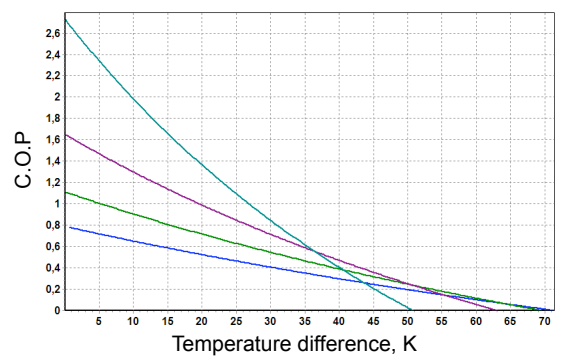
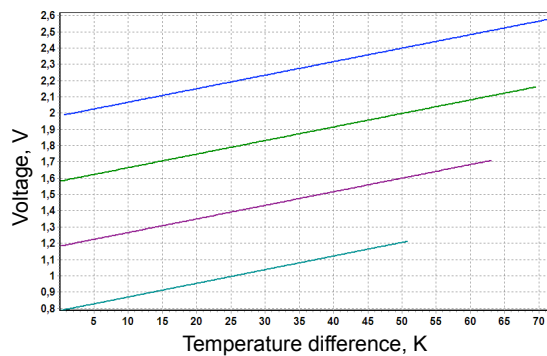
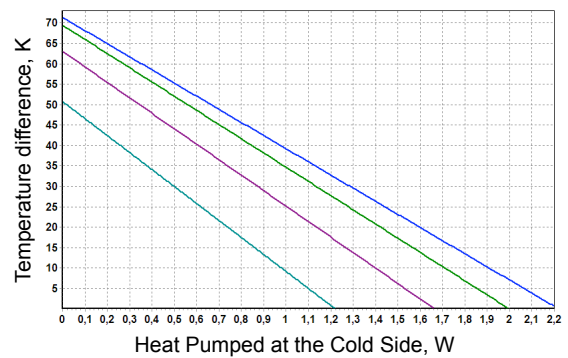
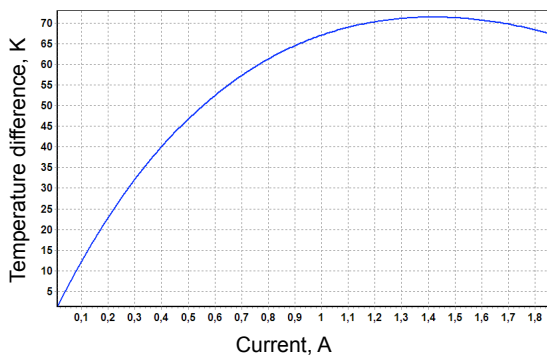

Color Legend: **Imax**, **0.8 Imax**, **0.6 Imax**, **0.4 Imax**

Performance Plots

1MD04-021-08

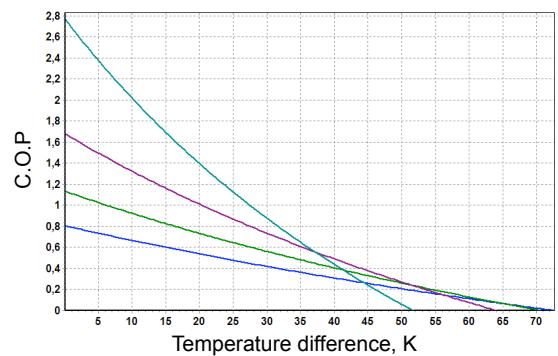
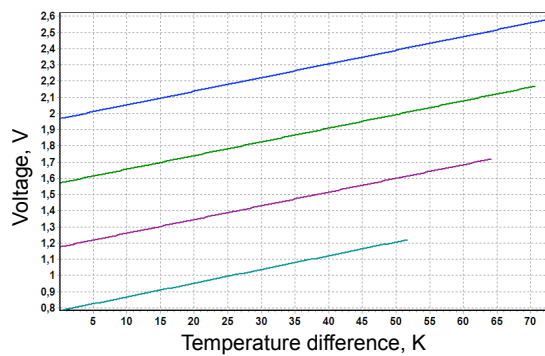
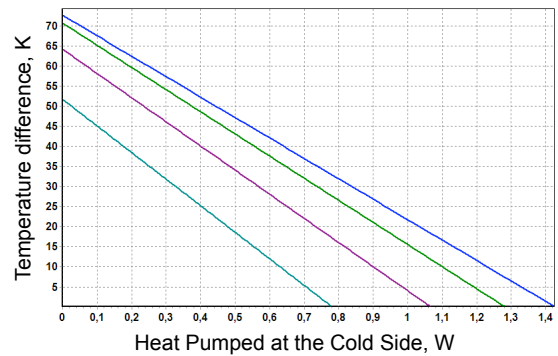
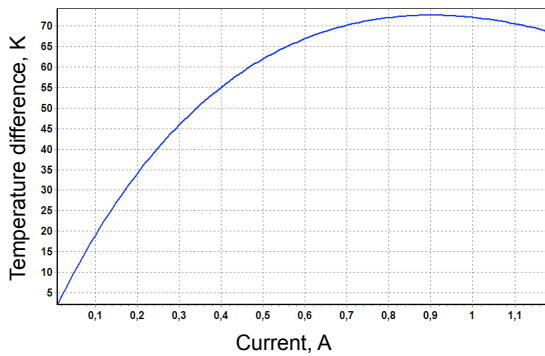

Performance Plots

1MD04-021-10

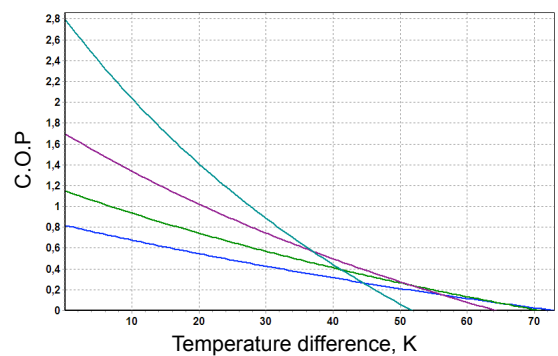
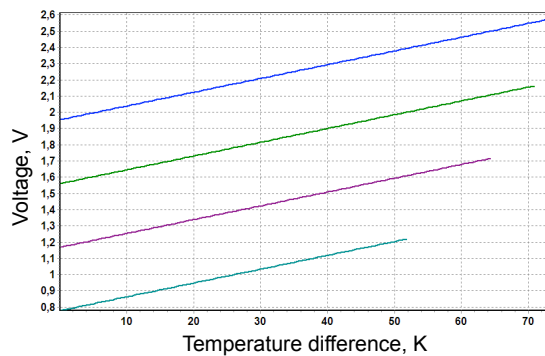
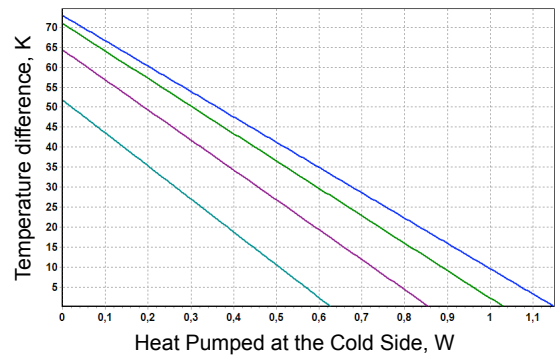
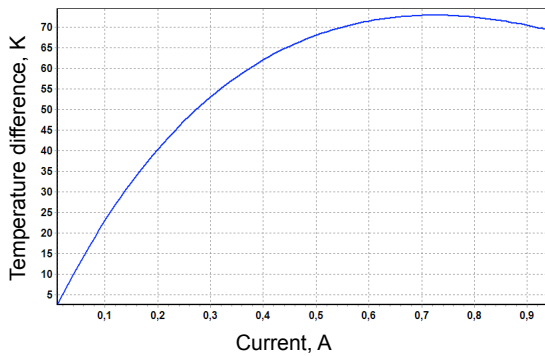

Color Legend: **I_{max}**, **0.8 I_{max}**, **0.6 I_{max}**, **0.4 I_{max}**

Performance Plots

1MD04-021-12

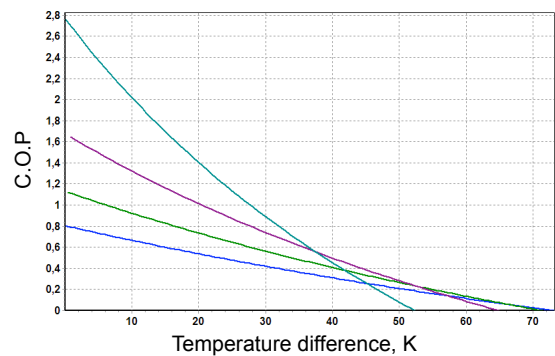
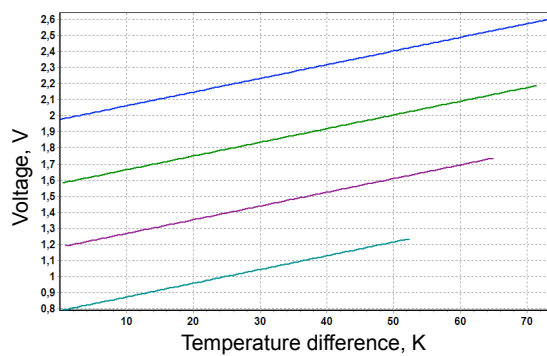
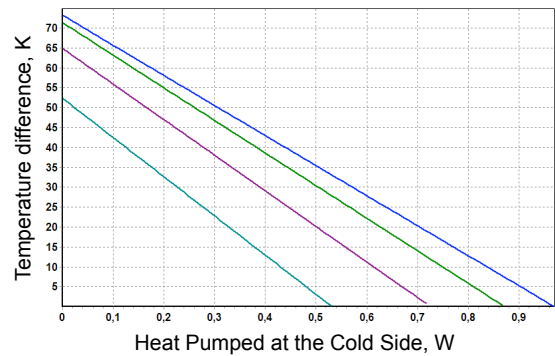
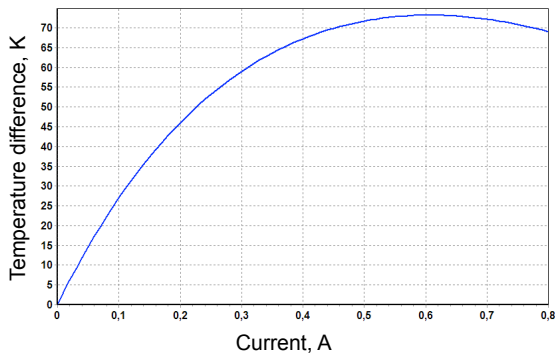

Performance Plots

1MD04-021-15

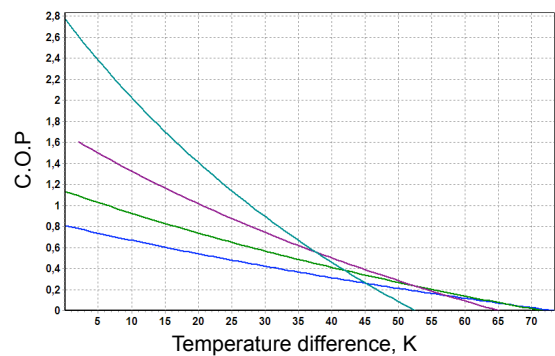
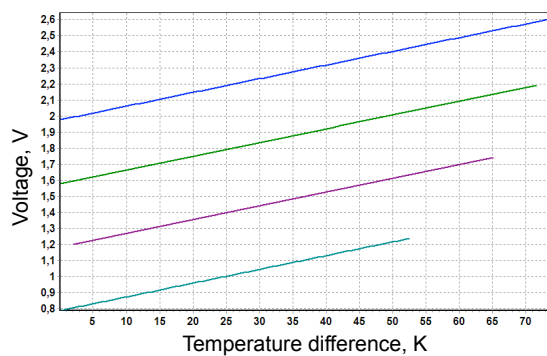
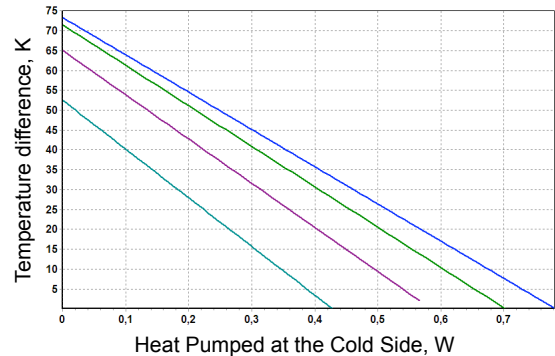
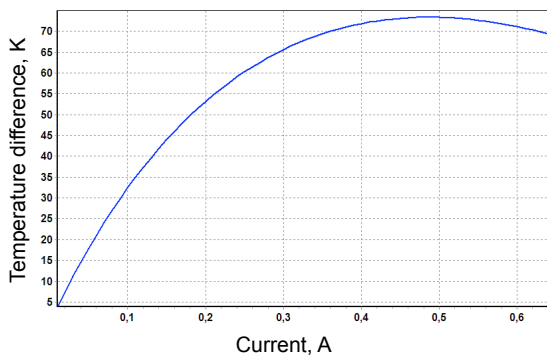

Color Legend: **Imax**, **0.8 Imax**, **0.6 Imax**, **0.4 Imax**

Additional Options

TEC Polarity

TEC Polarity can be changed for free by request. The specified in this datasheet polarity is typical. It can be reversed without charge in accordance to Customer application requirements.

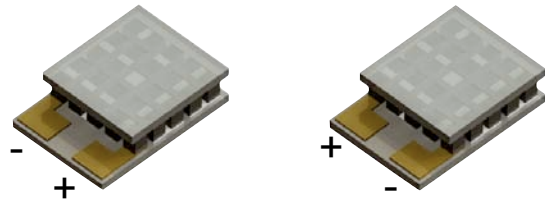

WB Posts or Pads

WB pads or WB posts solutions are available. WB pads (no posts) are provided as standard. WB Posts solution is provided in accordance to Customer's demands and depending of TEC height.

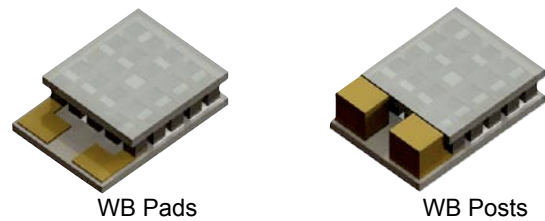

Customized Au Patterns

Customized Au patterns solution on TEC cold side ceramics is available. Selective Pre-tinning solution is available. Please, contact us for additional information about customized Au patterns requirements.

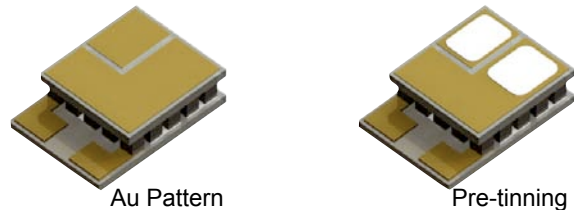

Application Tips

1. Never heat TE module more than 200°C (TEC assembled at 230°C).
2. Never use TE module without attached heat sink at hot (bottom) side.
3. Connect TE module to DC power supply according to polarity.
4. Do not apply DC current higher than I_{max}.

Installation

1. Mechanical Mounting. TEC is placed between two heat exchangers . This construction is fixed by screws or in another mechanical way. It is suitable for large modules (with dimensions 30x30mm and larger). Miniature types require other assembling methods in most cases.
2. Soldering. This method is suitable for a TE module with metallized outside surfaces. RMT provides this option and also makes pre-tinning for TE modules.
3. Glueing. It is an up-to-date method that is used by many customers due to availability of glues with good thermoconductive properties. A glue is usually based on some epoxy compound filled with some thermoconductive material such as graphite or diamond powders, silver, SiN and others. The application of a specific type depends on application features and the type of a TE module.

