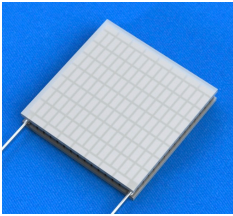

Performance Parameters

1MD06-127-xxTEG

	TEG PERFORMANCE AT SPECIFIED HOT SIDE TEMPERATURE												H mm
	Optimum Power Output P _{out} , W			Optimum Voltage U _{out} , V			Open Circuit Voltage U _{oc} , V			Resistance ACR, Ohm			
	85°C	55°C	35°C	85°C	55°C	35°C	85°C	55°C	35°C	85°C	55°C	35°C	
1MD06-127-03TEG	0.97	0.24	0.020	1.86	0.88	0.25	3.23	1.53	0.43	2.61	2.44	2.32	1.4
1MD06-127-05TEG	0.60	0.146	0.012							4.24	3.95	3.75	1.6
1MD06-127-08TEG	0.38	0.09	0.008							6.67	6.21	5.90	1.9
1MD06-127-10TEG	0.31	0.07	0.006							8.30	7.72	7.33	2.1
1MD06-127-12TEG	0.26	0.06	0.005							9.93	9.23	8.77	2.3
1MD06-127-15TEG	0.21	0.05	0.004							12.37	11.49	10.91	2.6

Performance values are specified for TEG cold side at +27°C, Dry Air. Optimum Power and Voltage are given at Optimum Load Resistance

Dimensions

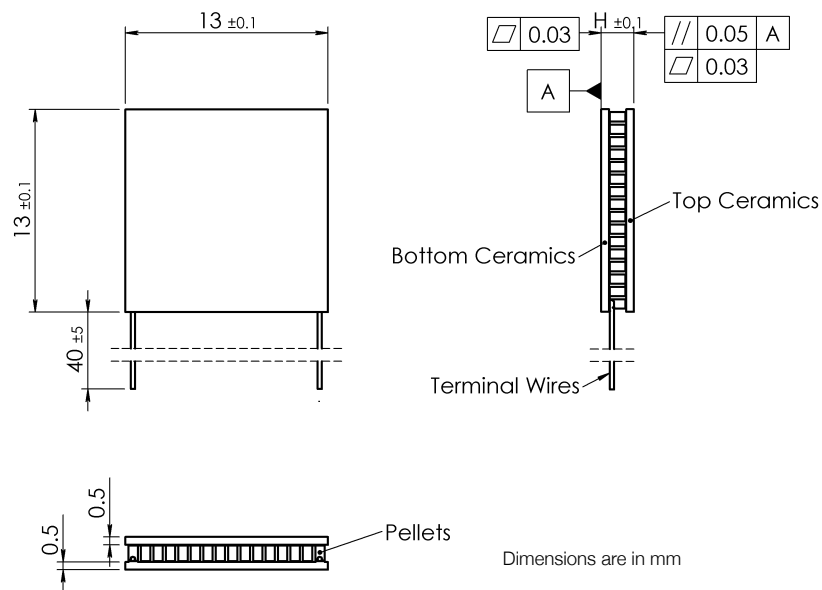

Manufacturing options

A. TEG Assembly:

- Solder Sn-Sb, $T_{\text{melt}}=230^{\circ}\text{C}$ (default assembly solder)
- Solder Au-Sn, $T_{\text{melt}}=280^{\circ}\text{C}$ (optional solution, by request)

B. TEG Ceramics:

- $\text{Al}_2\text{O}_3(100\%)$ - default
- AlN - by request

C. Ceramics Surface Options:

- Blank ceramics - default
- Metallized (Au plating)
- Metallized and pre-tinned with:
 - In-Sn, $T_{\text{melt}}=117^{\circ}\text{C}$
 - Sn-Bi, $T_{\text{melt}}=138^{\circ}\text{C}$
 - In-Ag, $T_{\text{melt}}=143^{\circ}\text{C}$
 - In, $T_{\text{melt}}=157^{\circ}\text{C}$
 - Pb-Sn, $T_{\text{melt}}=183^{\circ}\text{C}$
 - Optional type (can be specified by Customer)

D. Thermistors (optional)

Can be mounted to ceramics edge. Calibration is available by request.

E. Terminal contacts

- Blank, tinned Copper - default
- Insulated Wires
- Insulated, color coded
- WB pads or Posts (optional)
- Flip-Chip (optional)

Performance Data ————— 1MD06-127-03TEG

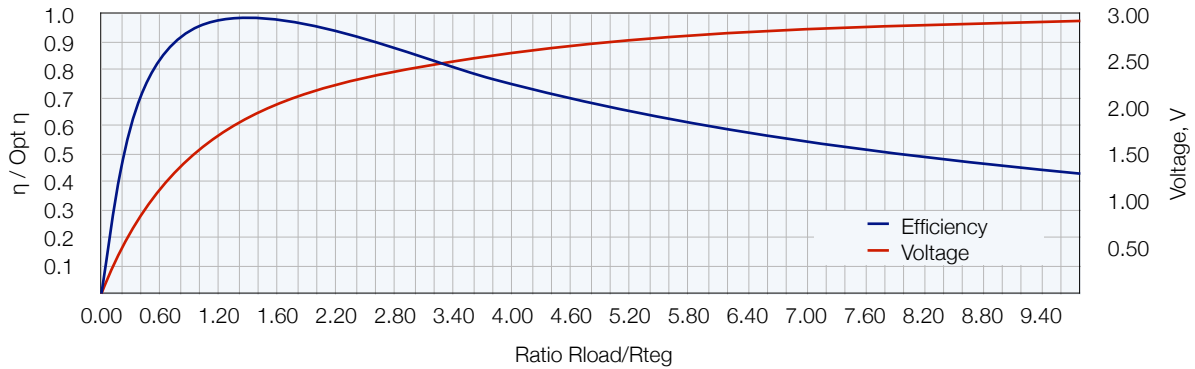
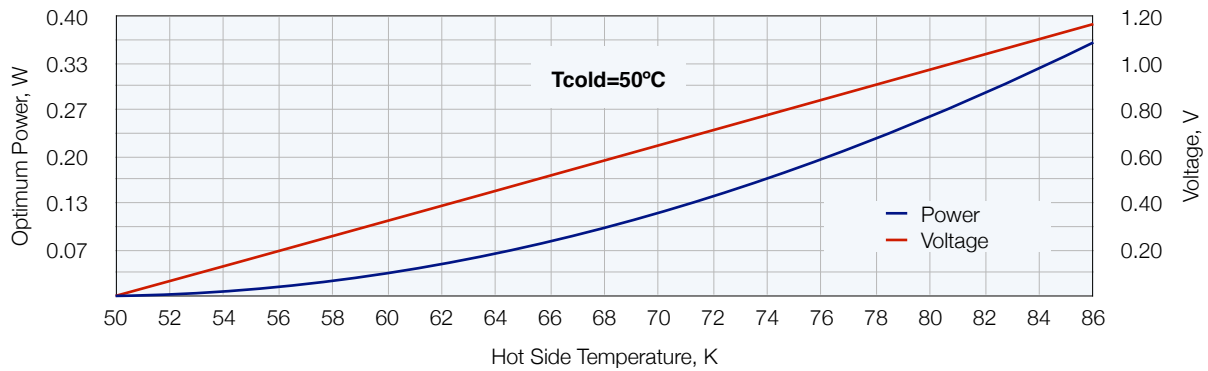
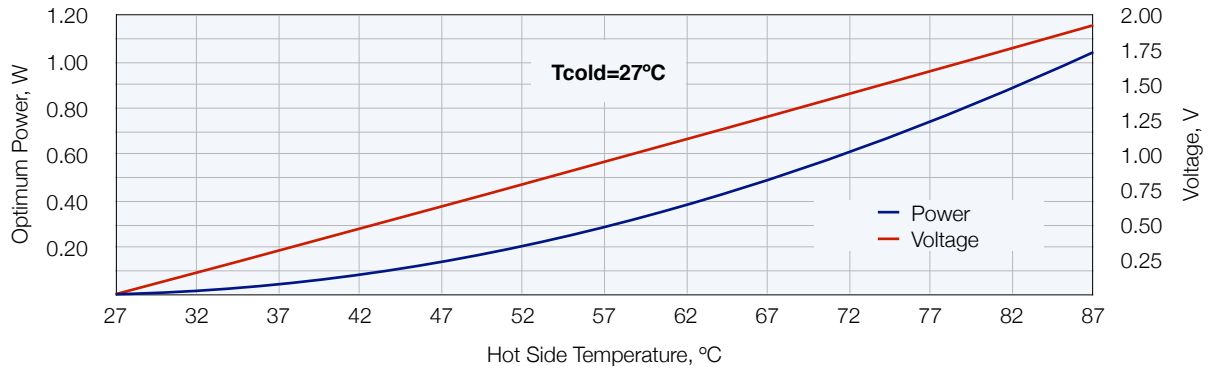

Parameter	Units	Values at Hot Side Temperature		
		85°C	55°C	35°C
Cold Side Temperature, Tcold	°C	27	27	27
Optimum Efficiency, Opt η	%	2.83	1.42	0.41
Optimum Power, Popt	W	0.975	0.236	0.020
Optimum Voltage, Uopt	V	1.860	0.884	0.249
AC Resistance, Rteg	Ohm	2.61	2.44	2.32
Optimum Load Resistance, Rload	Ohm	3.55	3.31	3.13
Open Circuit Voltage, Uoc	V	3.23	1.53	0.43
Short Circuit Current, Isc	A	1.24	0.63	0.19
Thermal Resistance, Rt	°C/W	1.68	1.68	1.68

Note: Power Generation performance charts are specified in Optimum conditions, dry air, with cold side temperature set at +27°C and 50°C. Heatsink thermal resistance is not included into estimations.

Performance Data ————— 1MD06-127-05TEG

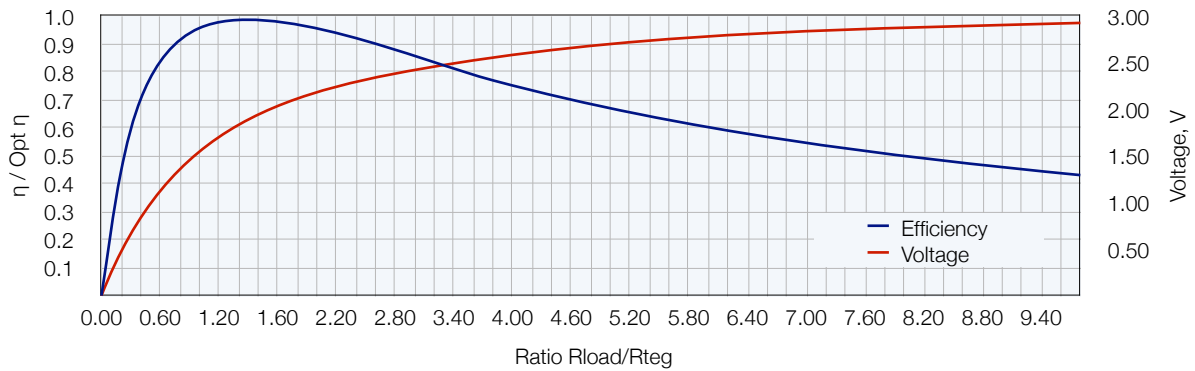
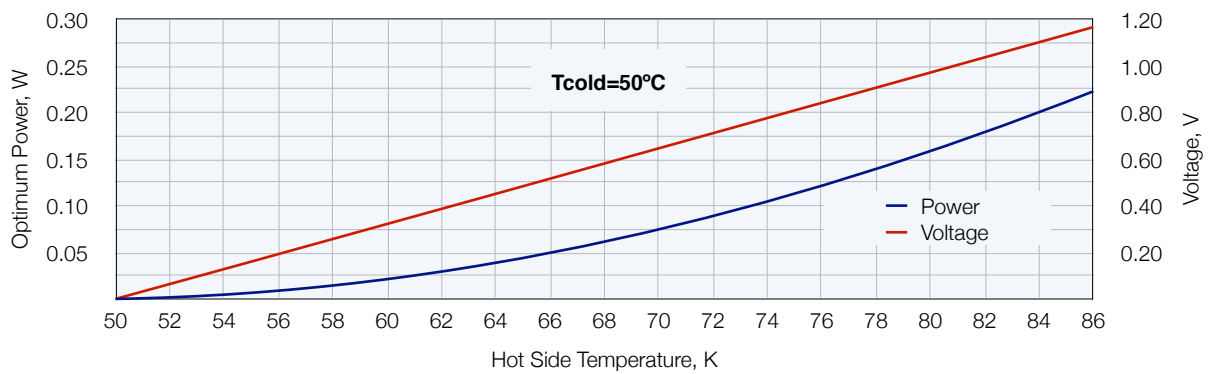
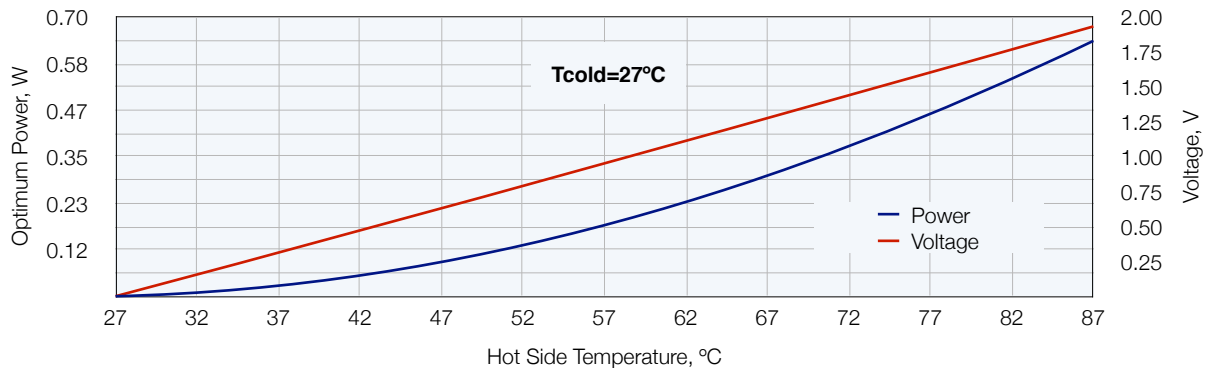

Parameter	Units	Values at Hot Side Temperature		
		85°C	55°C	35°C
Cold Side Temperature, Tcold	°C	27	27	27
Optimum Efficiency, Opt η	%	2.81	1.41	0.41
Optimum Power, Popt	W	0.600	0.146	0.012
Optimum Voltage, Uopt	V	1.866	0.884	0.249
AC Resistance, Rteg	Ohm	4.24	3.95	3.75
Optimum Load Resistance, Rload	Ohm	5.80	5.37	5.10
Open Circuit Voltage, Uoc	V	3.23	1.53	0.43
Short Circuit Current, Isc	A	0.76	0.39	0.12
Thermal Resistance, Rt	°C/W	2.72	2.71	2.71

Note: Power Generation performance charts are specified in Optimum conditions, dry air, with cold side temperature set at +27°C and 50°C. Heatsink thermal resistance is not included into estimations.

Performance Data ————— 1MD06-127-08TEG

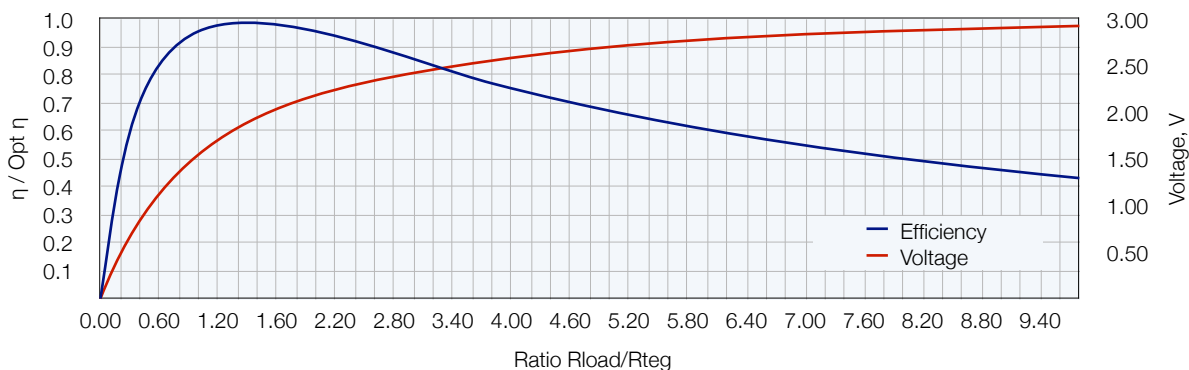
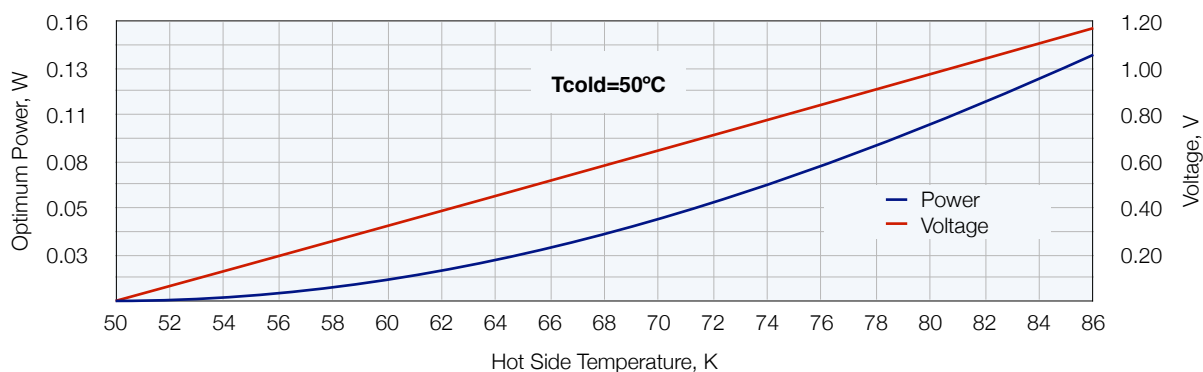
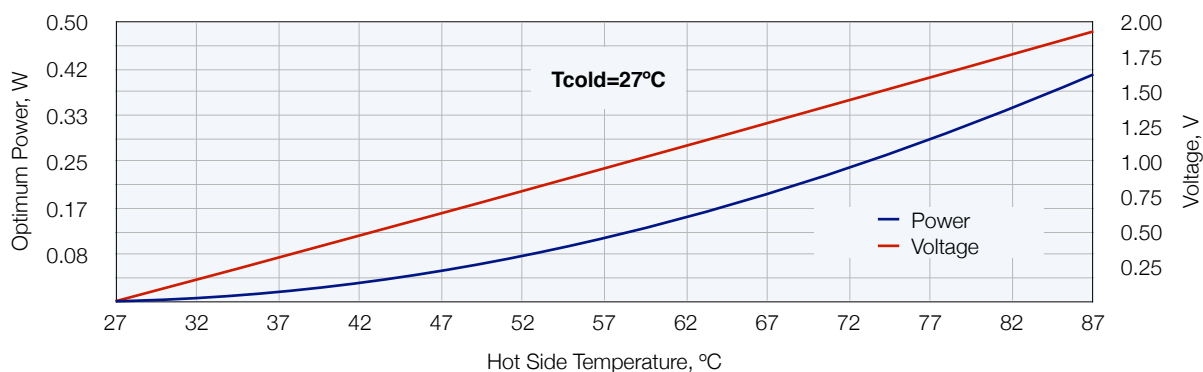

Parameter	Units	Values at Hot Side Temperature		
		85°C	55°C	35°C
Cold Side Temperature, Tcold	°C	27	27	27
Optimum Efficiency, Opt η	%	2.79	1.40	0.41
Optimum Power, Popt	W	0.381	0.092	0.008
Optimum Voltage, Uopt	V	1.866	0.887	0.249
AC Resistance, Rteg	Ohm	6.67	6.21	5.90
Optimum Load Resistance, Rload	Ohm	9.14	8.51	8.03
Open Circuit Voltage, Uoc	V	3.23	1.53	0.43
Short Circuit Current, Isc	A	0.48	0.25	0.07
Thermal Resistance, Rt	°C/W	4.25	4.25	4.25

Note: Power Generation performance charts are specified in Optimum conditions, dry air, with cold side temperature set at +27°C and 50°C. Heatsink thermal resistance is not included into estimations.

Performance Data ————— 1MD06-127-10TEG

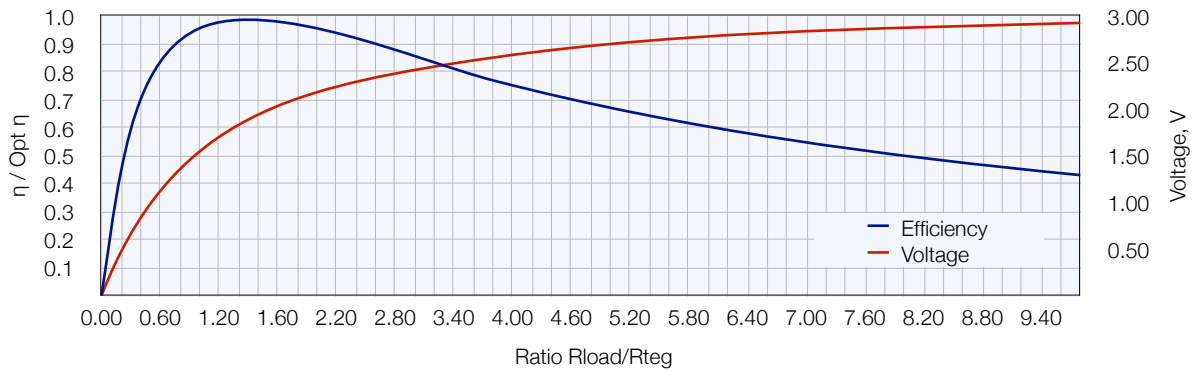
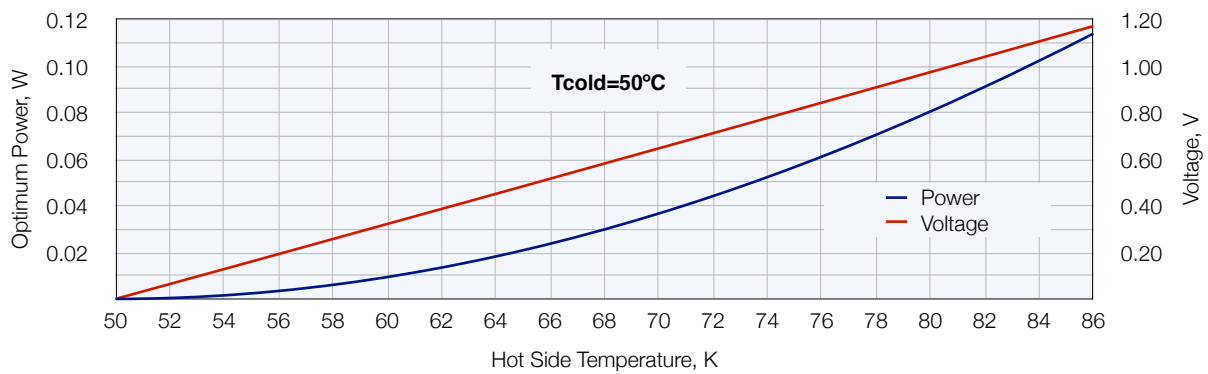
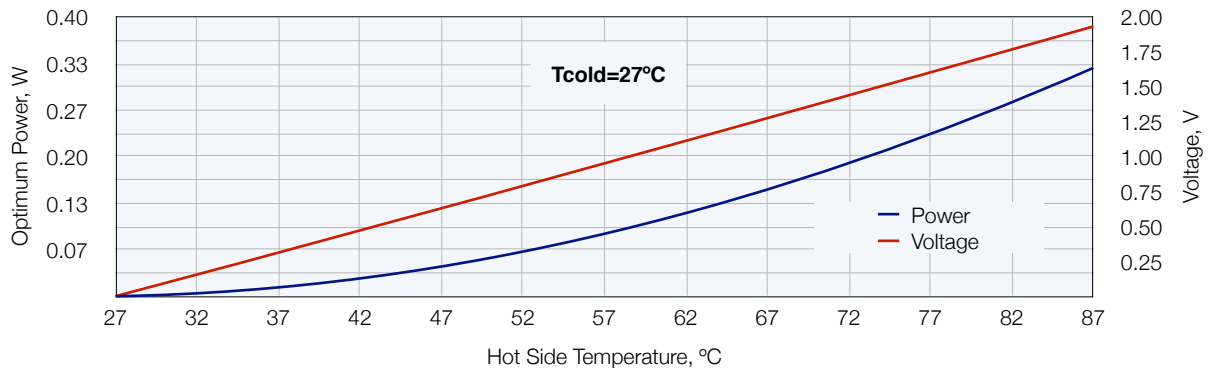

Performance data at Optimum Load Resistance (Rload)	Parameter	Units	Values at Hot Side Temperature		
			85°C	55°C	35°C
			Cold Side Temperature, Tcold	°C	27
Optimum Efficiency, Opt η	%	2.78	1.40	0.41	
Optimum Power, Popt	W	0.306	0.074	0.006	
Optimum Voltage, Uopt	V	1.866	0.887	0.249	
AC Resistance, Rteg	Ohm	8.30	7.72	7.33	
Optimum Load Resistance, Rload	Ohm	11.37	10.58	9.97	
Open Circuit Voltage, Uoc	V	3.23	1.53	0.43	
Short Circuit Current, Isc	A	0.39	0.20	0.06	
Thermal Resistance, Rt	°C/W	5.26	5.26	5.26	

Note: Power Generation performance charts are specified in Optimum conditions, dry air, with cold side temperature set at +27°C and 50°C. Heatsink thermal resistance is not included into estimations.

Performance Data ————— 1MD06-127-12TEG

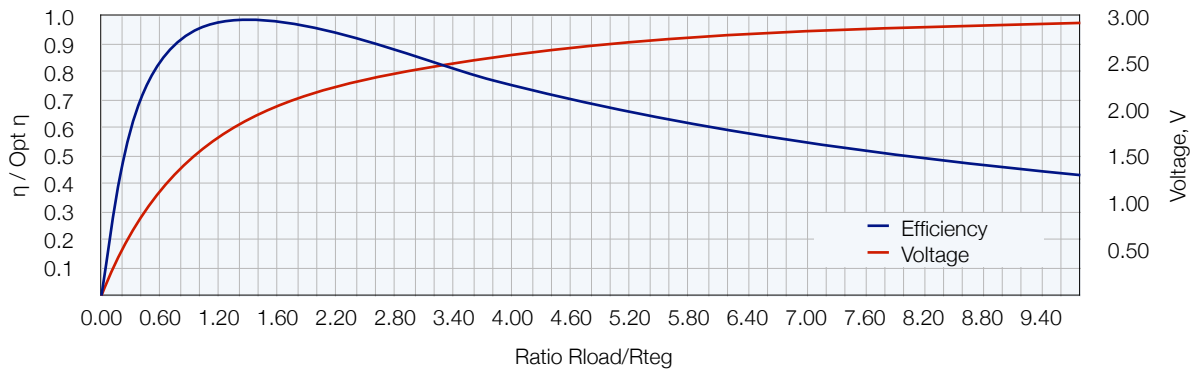
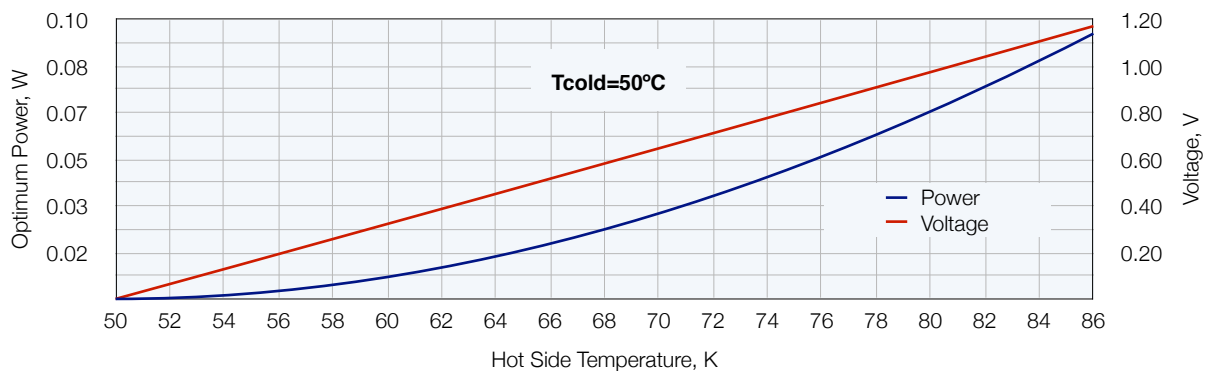
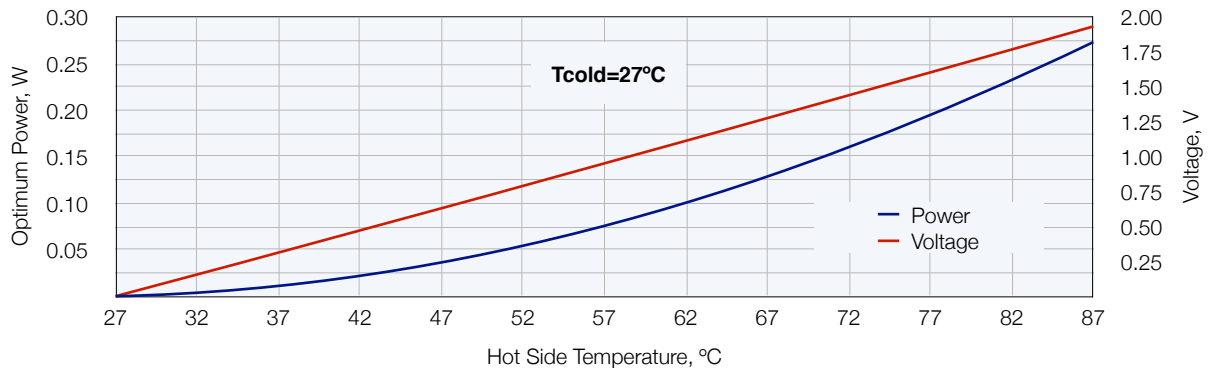

Performance data at Optimum Load Resistance (Rload)	Parameter	Units	Values at Hot Side Temperature		
			85°C	55°C	35°C
			Cold Side Temperature, Tcold	°C	27
Optimum Efficiency, Opt η	%	2.77	1.39	0.41	
Optimum Power, Popt	W	0.256	0.062	0.005	
Optimum Voltage, Uopt	V	1.866	0.887	0.249	
AC Resistance, Rteg	Ohm	9.93	9.23	8.77	
Optimum Load Resistance, Rload	Ohm	13.60	12.64	11.92	
Open Circuit Voltage, Uoc	V	3.23	1.53	0.43	
Short Circuit Current, Isc	A	0.33	0.17	0.05	
Thermal Resistance, Rt	°C/W	6.27	6.27	6.28	

Note: Power Generation performance charts are specified in Optimum conditions, dry air, with cold side temperature set at +27°C and 50°C. Heatsink thermal resistance is not included into estimations.

Performance Data ————— 1MD06-127-15TEG

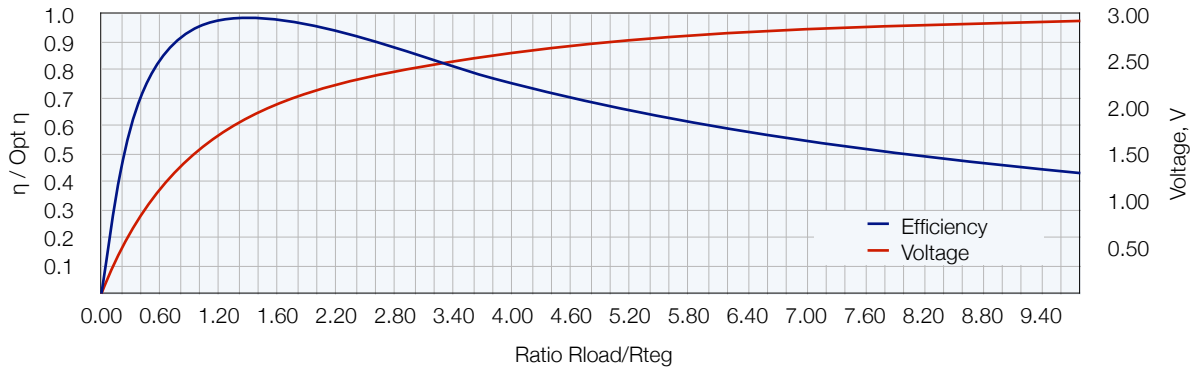
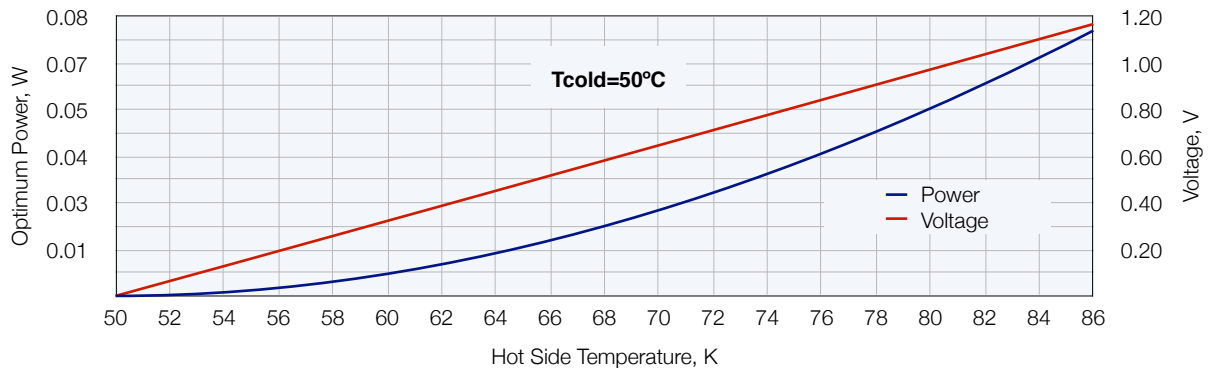
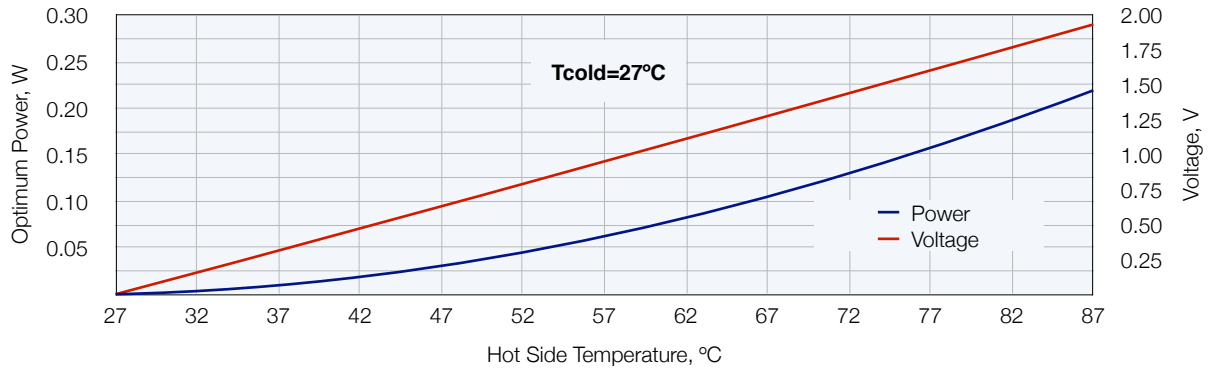

Parameter	Units	Values at Hot Side Temperature		
		85°C	55°C	35°C
Cold Side Temperature, Tcold	°C	27	27	27
Optimum Efficiency, Opt η	%	2.75	1.39	0.41
Optimum Power, Popt	W	0.205	0.050	0.004
Optimum Voltage, Uopt	V	1.866	0.887	0.249
AC Resistance, Rteg	Ohm	12.37	11.49	10.91
Optimum Load Resistance, Rload	Ohm	16.94	15.75	14.84
Open Circuit Voltage, Uoc	V	3.23	1.53	0.43
Short Circuit Current, Isc	A	0.26	0.13	0.04
Thermal Resistance, Rt	°C/W	7.76	7.78	7.79

Note: Power Generation performance charts are specified in Optimum conditions, dry air, with cold side temperature set at +27°C and 50°C. Heatsink thermal resistance is not included into estimations.

Thermolectric Generator Overview

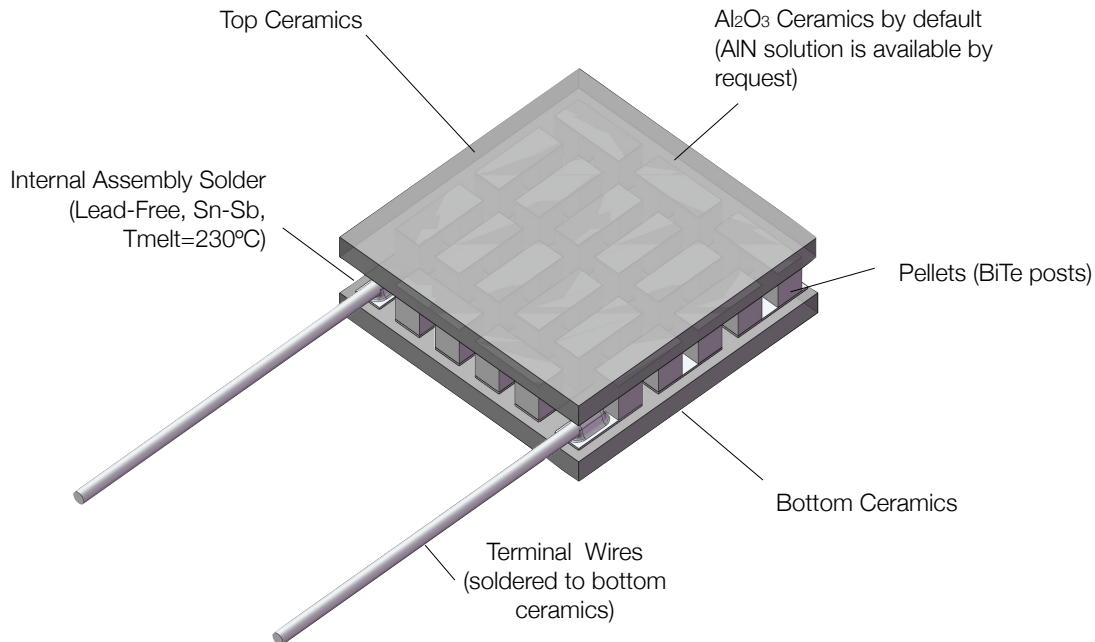

Application Tips

1. Never heat TEG module more than 200°C (TEG is assembled at 230°C).
2. TEG module to be fixed between hot and cold exchangers with an optimal thermal contact for the best efficiency. Improper contact may reduce ΔT level and power output.
3. TEG polarity depends on applied hot and cold side orientation

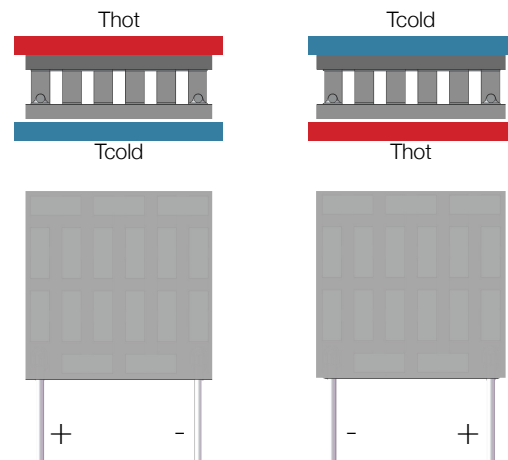

Installation

1. **Mechanical Mounting.** TEG is placed between two heat exchangers. This construction is fixed by screws or in another mechanical way. It is suitable for relatively large TEG modules (with dimensions 15x15mm² and larger). Miniature TEG types may require another assembling methods.
1. **Soldering.** This method is suitable for a TEG module with metallized outside surfaces. RMT provides this option and also makes pre-tinning for TE generators.
2. **Glueing.** It is an up-to-date method that is used by many customers due to availability of glues with good thermoconductive properties. A glue is usually based on some epoxy compound filled with some thermoconductive material such as graphite or diamond powders, silver, SiN and others. The application of a specific type depends on application features and the type of a TEG module.

Additional Options

Terminal Wires Options

The wires by default are of tinned Copper, blank (not insulated). Various options for isolated wires are available by request. The available solutions include isolated wires, isolated color-coded wires, flexible multicore wires and more.

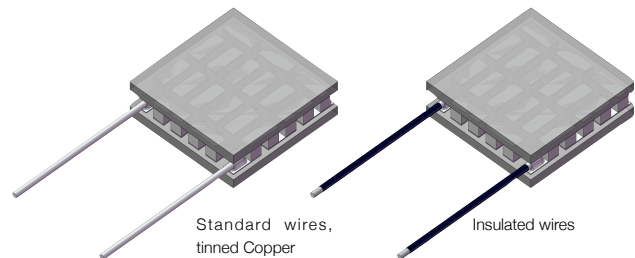

Terminal Connection Modification

TE Generator terminal contacts can be modified from standard wired solution to WB connection or Flip-Chip if required.

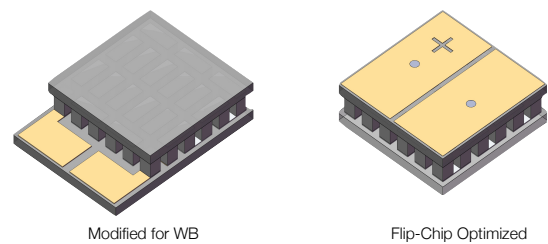

TEG Height Modification

Standard thermoelectric generator height can be modified without performance changes by using ceramics of different thickness. Standard thermoelectric generator height (specified in this datasheet) may be modified in a range -0.5...+1.0mm.

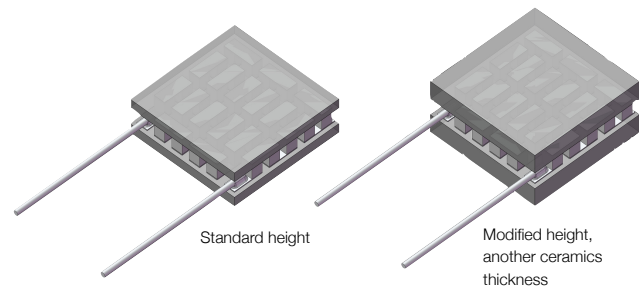

TEG Shape Modification

Standard thermoelectric generator shape can be modified without performance changes RMT has full-featured flexibility with thermoelectric generator shape and ceramics modification.

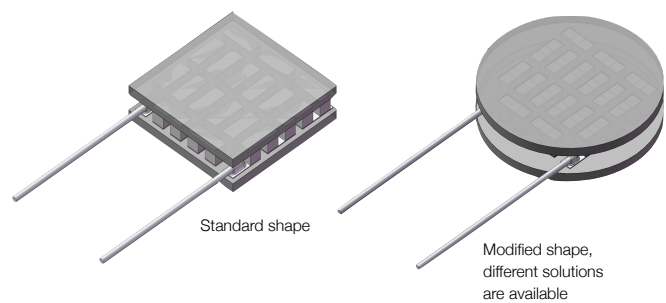

Thermoelectric Generator Basics

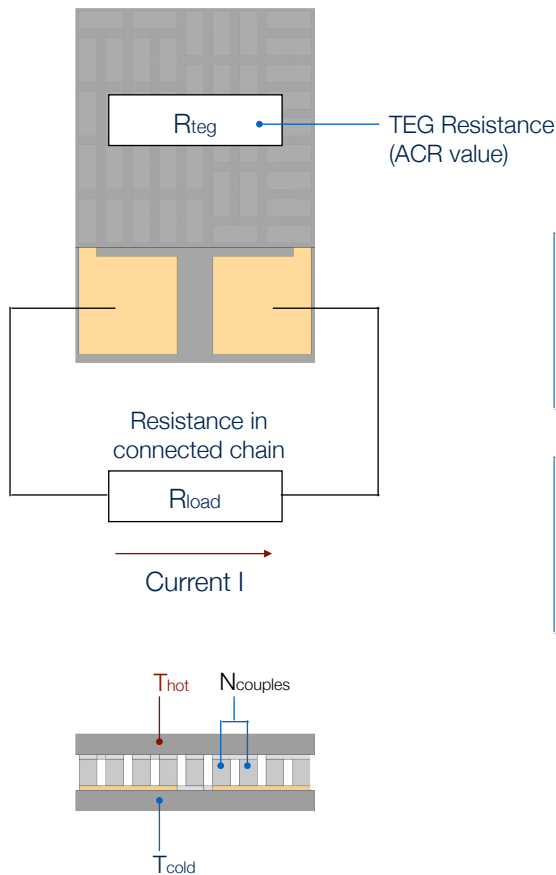

$$\alpha = 400\mu\text{V/K}$$

Simplified TE Generator estimations

The level of power output of thermoelectric generator in conditions specified can be estimated by the following formulas.

$$E = \alpha \times (T_{\text{hot}} - T_{\text{cold}}) \times N$$

$$I = \frac{E}{(R_{\text{teg}} + R_{\text{load}})}$$

$$P_{\text{out}} = I^2 \times R_{\text{load}}$$

Getting data from TEG type name

RMT thermoelectric generators have a nomenclature system that allows to get the required data for estimations quickly.

$$1\text{MD06-}\underline{127}\text{-05TEG}$$

|
N_{couples}

General R_{teg} (ACR) values are specified in the datasheet in main table (page 1). Thermoelectric generator R_{teg} value depends on the ambient temperature.

For the precise estimations, please, contact RMT specialists directly.

Thermoelectric Generator Basics

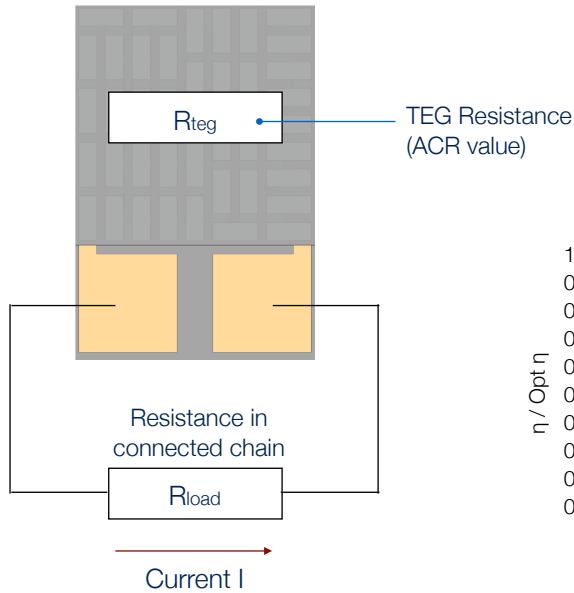

Resistances and TEG Efficiency

Thermoelectric generator best efficiency is reached at Load Resistance (R_{load}) close to thermoelectric generator resistance R_{teg} .

In most cases thermoelectric generator best efficiency is reached at R_{load}/R_{teg} ratio in a range 1.2 - 1.4

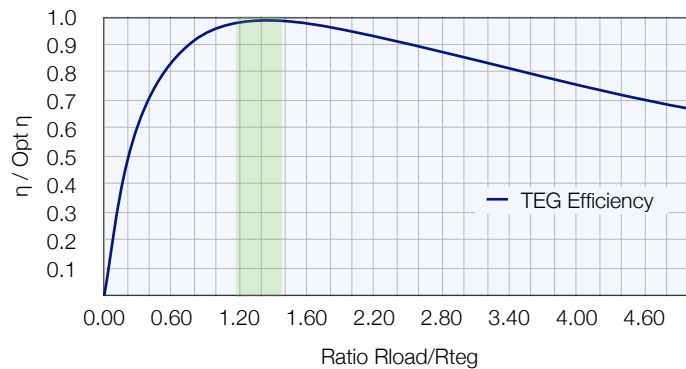

Output voltage and DC-DC converters

DC-DC converters are recommended to use with miniature thermoelectric generators, especially in low dT mode.

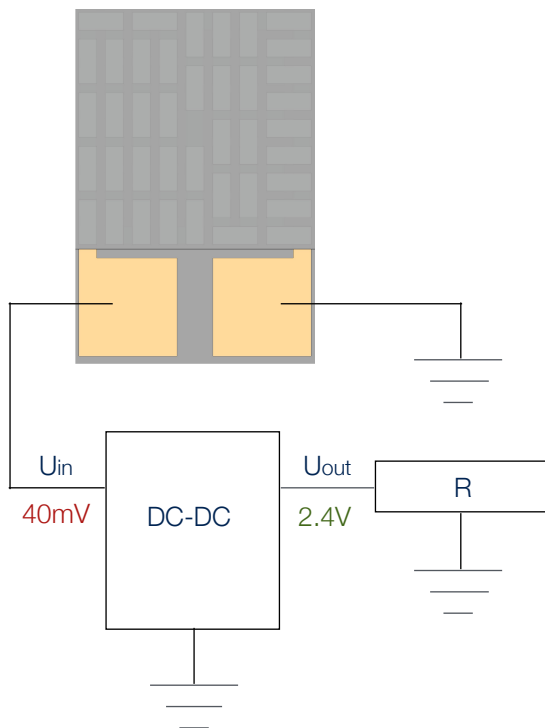

Contacts

HEAD OFFICE

46 Warshavskoe shosse. Moscow 115230 Russia

Tel: +7-499-678-20-82

Fax: +7-499-678-20-83

E-mail: info@rmtltd.ru

CHINA

翰銓科技香港有限公司

Hantech Technology

RM566,5/F,Hanjing Mansion,Nanshan District,Shenzhen,China

Tel:+86-0755-86215941

Fax:+86-0755-86053039

Cell: 13760105325

E-mail: bob.han@protecltd.com

XIAMEN ZIBO OPTOELECTRONIC CO. LTD.

Room 120, Chuanye Building Chuanye Park,

Xiamen Torch Hi-Tech Industrial Development Zone

Xiamen, China , 361006

Tel: +86-592-5654050

Fax: +86-13606026187

E-mail: wentyliu@foxmail.com (Wenty Liu)

KOREA

Sunflower Energy

1F, 665-6, Pungdeokcheon-dong, Suji-gu,

Yongin-si, Gyeonggi-do, Korea

Tel: +82 312767992

Fax: +82 312767993

Web site: <http://www.sunfl.co.kr>

Legal Notice

All logos, images, trademarks and product names (collectively Materials) are proprietary to RMT Ltd and/ or any of its affiliates, or subsidiaries, or other respective owners that have granted RMT Ltd the permission and/or license to use such Materials. All images are provided by RMT Ltd. and are subjects of copyright protection.

RMT Ltd do not grant a copyright license (express or implied) to the Recipient, except that Recipient may reproduce the logos, images and text materials in this press-release without any alteration for non-promotional or editorial purposes only with a written note about materials owner.

Copyright protection warning

Graphic materials and text from this datasheet may not be used commercially without a prior response in writing on company letterhead and signed by RMT Ltd authority. Thank you for respecting the intellectual property rights protected by the International Copyright laws.

Warning: All datasheet images contain RMT Ltd hidden watermark for the immediate proof of their origin.

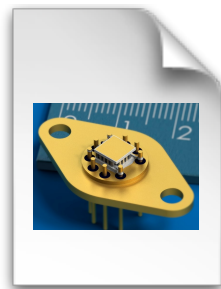

RMT Image

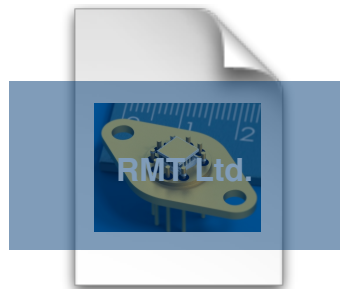

Hidden Watermark