

Performance Parameters

TO812.3MD06071xx

Mounted TEC Type	ΔT_{max} K	Q_{max} W	I_{max} A	U_{max} V	R_t K/W	H mm
3MD06-071-xx (N=71)						
3MD06-071-05	109	1.56	2.12	5.7	1.10	3.8
3MD06-071-08	112	1.04	1.41			4.7
3MD06-071-10	114	0.85	1.15			5.3
3MD06-071-12	114	0.72	0.97			5.9
3MD06-071-15	115	0.59	0.79			6.8

Performance data are given at 300K, vacuum

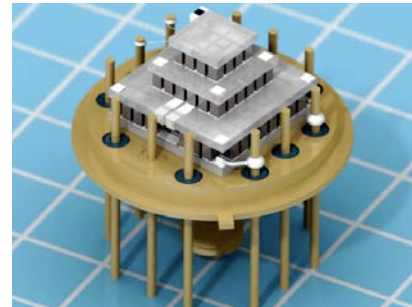

Technical Drawing

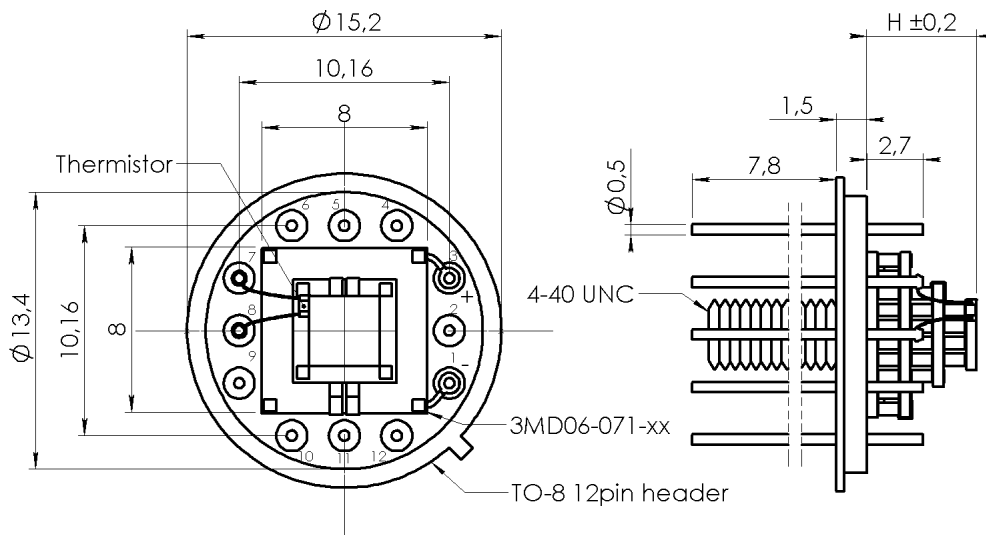

Options available

A. Header material

Kovar

B. Header surface finish

1. Au plating (base and pins)
2. Ni plating with Au plated pins

C. TEC Mounting

1. Soldering
 - 1.1 Solder 117 (InSn, Tmelt=117°C)
 - 1.2 Solder 138 (SnBi, Tmelt=138°C)
 - 1.3 Solder 183 (PbSn, Tmelt=183°C)
 - 1.4 Solder 199 (SnZn, Tmelt=199°C)
2. Epoxy gluing

D. TEC Leads Connection

Solder 230 (SnSb, Tmelt =230°C)

E. TEC Ceramics

1. Pure Al₂O₃ (100%) - standard
2. Alumina (Al₂O₃ - 96%) - optional
3. Aluminum Nitride (AlN) - optional

F. TEC Cold Side Finish

1. Clear ceramics
2. Metallized
 - 2.1 Ni / Sn(Bi)
 - 2.2 Gold plating
3. Metallized and Pre-tinned
 - 3.1 Solder 94 (PbSnBi, Tmelt=94°C)
 - 3.2 Solder 117 (InSn, Tmelt=117°C)
 - 3.3 Solder 138 (SnBi, Tmelt=138°C)
 - 3.4 Solder 183 (PbSn, Tmelt=183°C)
 - 3.5 Solder 199 (SnZn, Tmelt=199°C) (limited applications)

G. Thermistor (optional)

NTC thermistor type TB
Resistance nominal
1. 2.2 kOhm@20C
2 10.0 kOhm@20C
Individual calibration is available in -65..+85°C

H. Thermistor Mounting

Epoxy Gluing

J. Thermistor Leads Connect

Soldering by Solder 230 (SnSb, Tmelt=230°C)

K. Pinout configuration

Can be specified by customer

Performance Plots

TO812.3MD0607105

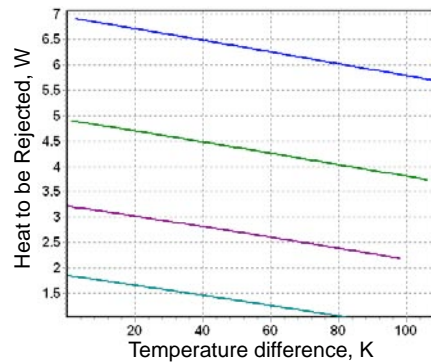
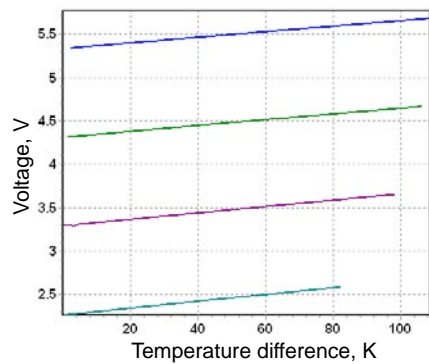
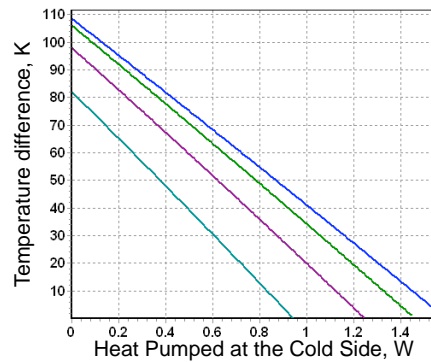
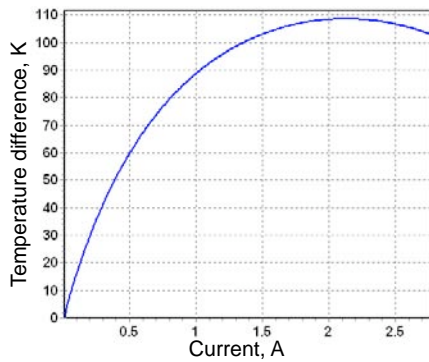

Performance Plots

TO812.3MD0607108

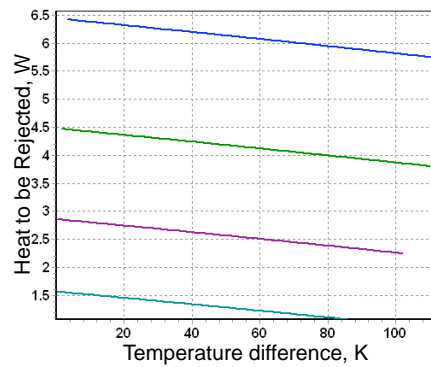
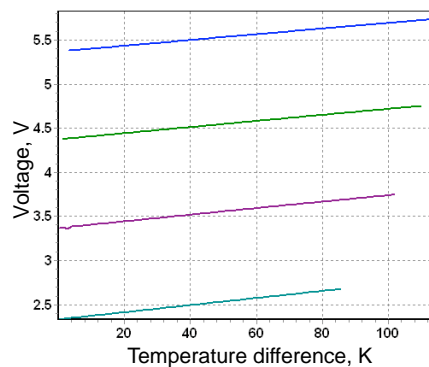
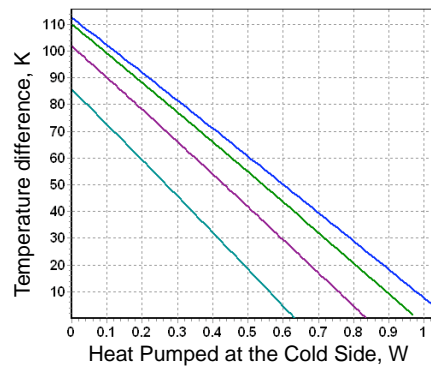
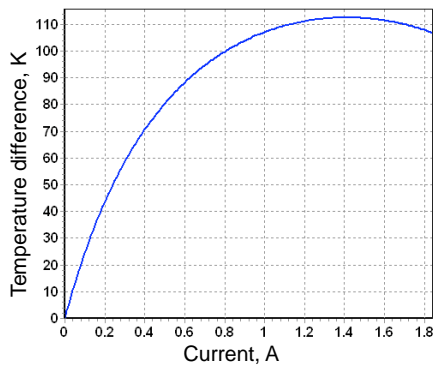

Color Legend: $I_{max}, 0.8 I_{max}, 0.6 I_{max}, 0.4 I_{max}$

Performance Plots TO812.3MD0607110

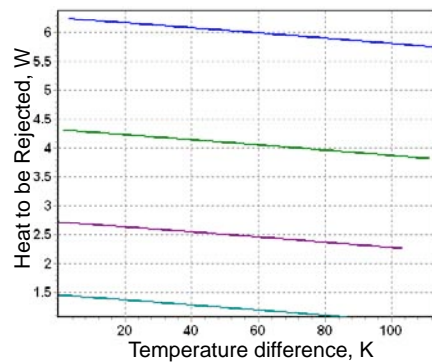
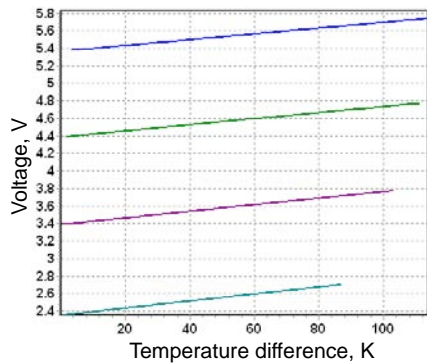
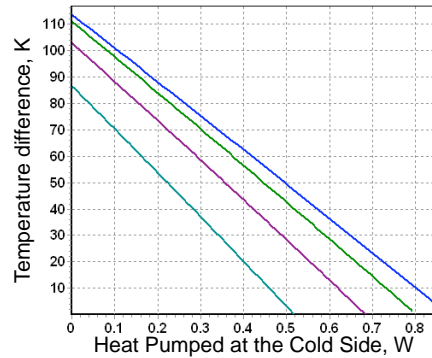
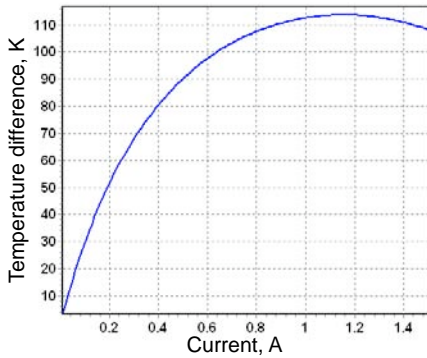

Performance Plots TO812.3MD0607112

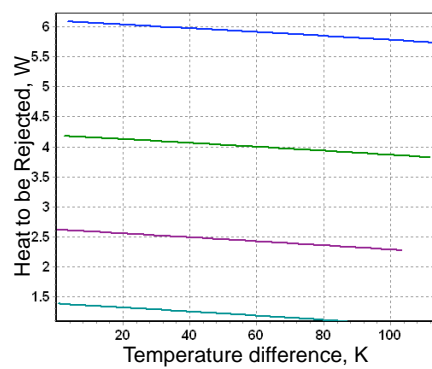
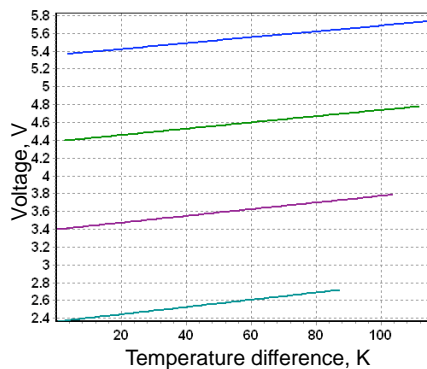
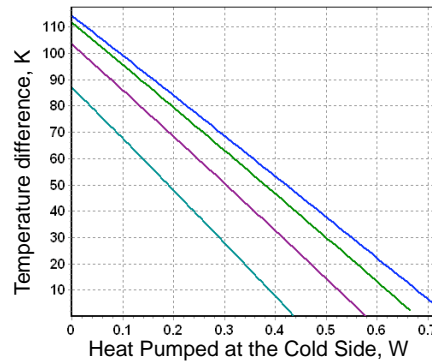
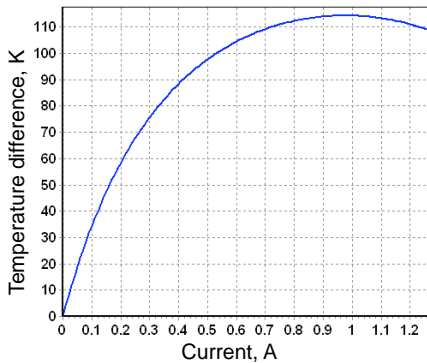

Color Legend: I_{max}, 0.8 I_{max}, 0.6 I_{max}, 0.4 I_{max}

Performance Plots

TO812.3MD0607115

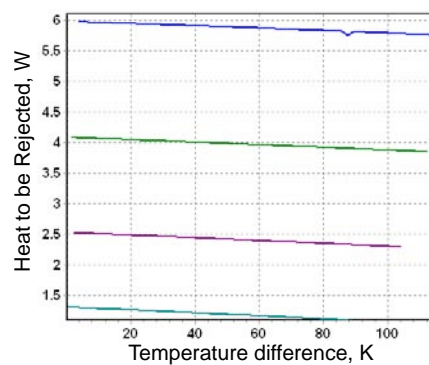
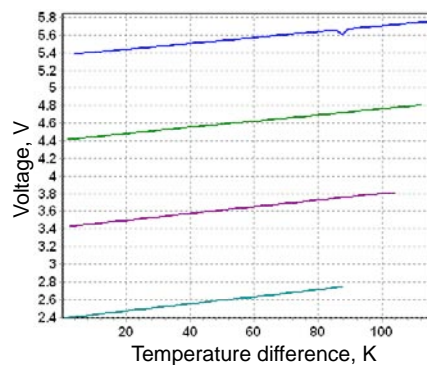
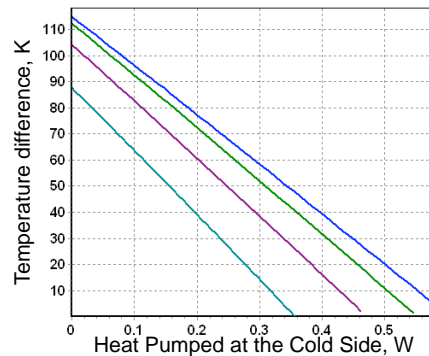
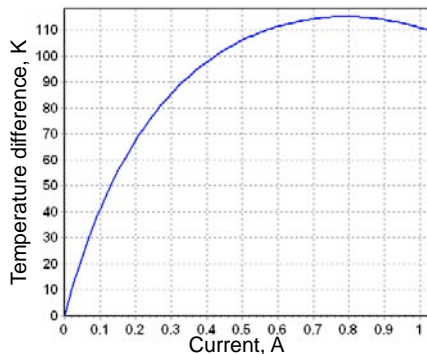

Color Legend: 0.8 I_{max}, 0.6 I_{max}, 0.4 I_{max}

Application Tips

1. Never heat TE module more than 200°C (TEC assembled at 230°C).
2. Never use TE module without attached heat sink at hot (bottom) side.
3. Connect TE module to DC power supply according to polarity.
4. Do not apply DC current higher than I_{max}.

Installation

1. Soldering of object to be cooled.
Method suitable for a TE module with the metallized cold side (Ordering Options. Item F). Soldering requires careful procedures:
 - A. Never overheat TEC (Cautions. Item 1).
 - B. Use solder with melting point less than TEC mounting solder (Ordering Options. Item C).
2. Gluing of object to be cooled.
Method available by glues with good thermoconductive properties. Not recommended for high vacuum applications and long operations at high temperature.

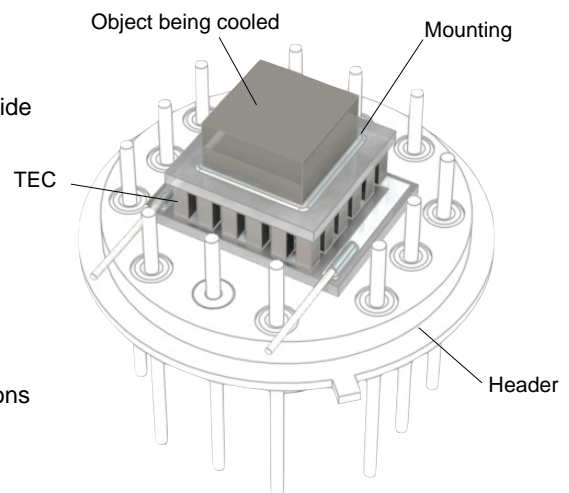

Performance plots are created with TECCAD Software. TECCAD is free software developed by RMT Ltd specially for optimal TE modules or sub-assemblies selecting and analyzing. It is available for download from RMT Ltd website.