

# Thermoelectric Sub-mount Datasheet RMT Ltd.

## Performance parameters TO812.2MC06021xx

Mounted TEC Type	DT <sub>max</sub> , K	Q <sub>max</sub> , W	I <sub>max</sub> , A	U <sub>max</sub> , V	R <sub>t</sub> , K/W	H, mm
2MC06-021-05	98	1.12	2.6	2.09	1.31	2.7
2MC06-021-08	101	0.74	1.7			3.3
2MC06-021-10	101	0.61	1.4			3.7
2MC06-021-12	102	0.51	1.2			4.1
2MC06-021-15	102	0.41	0.9			4.7

Performance data are given for  $T_{hot}=300K$  vacuum

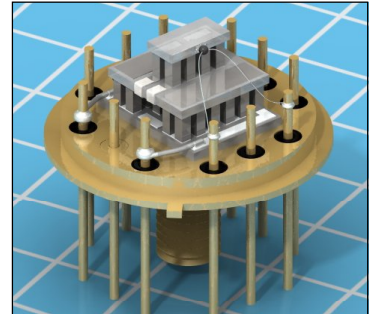

## Technical Drawing

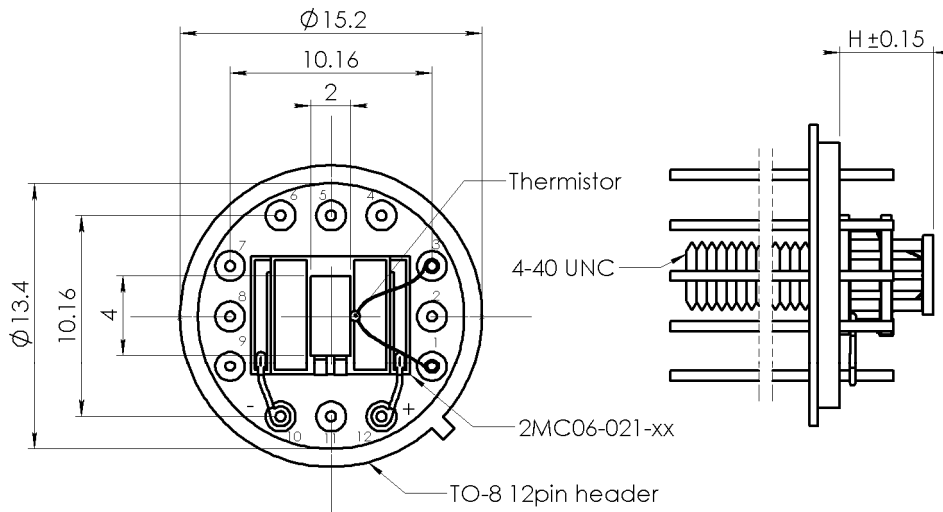

## Ordering Options

### A. Header material

Kovar

### B. Header finish

1. Gold plating
2. Ni plating

### C. TEC Mounting

1. Soldering
  - 1.1 Solder 117 (InSn,  $T_{melt}=117^{\circ}C$ )
  - 1.2 Solder 138 (SnBi,  $T_{melt}=138^{\circ}C$ )
  - 1.3 Solder 183 (PbSn,  $T_{melt}=183^{\circ}C$ )
  - 1.4 Solder 199 (SnZn,  $T_{melt}=199^{\circ}C$ )
2. Epoxy gluing

### D. TEC Leads Connection

Solder 230 (SnSb,  $T_{melt}=230^{\circ}C$ )

### E. TEC Ceramics

1. Pure  $Al_2O_3$  (100%) - standard
2. Alumina ( $Al_2O_3$  - 96%) - optional
3. Aluminum Nitride (AlN) - optional

### F. TEC Cold Side Finish

1. Clear ceramics
2. Metallized
  - 2.1 Ni / Sn(Bi)
  - 2.2 Gold plating
3. Metallized and Pre-tinned
  - 3.1 Solder 94 (PbSnBi,  $T_{melt}=94^{\circ}C$ )
  - 3.2 Solder 117 (InSn,  $T_{melt}=117^{\circ}C$ )
  - 3.3 Solder 138 (SnBi,  $T_{melt}=138^{\circ}C$ )
  - 3.4 Solder 183 (PbSn,  $T_{melt}=183^{\circ}C$ )
  - 3.5 Solder 199 (SnZn,  $T_{melt}=199^{\circ}C$ )

### G. Thermistor (optional)

NTC thermistor type TB  
Resistance nominal  
1. 2.2 kOhm@20C  
2. 10.0 kOhm@20C

Individual calibration is available in -65..+85°C

### H. Thermistor Mounting

Epoxy Gluing

### I. Thermistor Leads Connect

Solder 230 (SnSb,  $T_{melt}=230^{\circ}C$ )

### J. Pinout configuration

Can be specified by customer

# Thermoelectric Sub-mount Datasheet RMT Ltd.

## TO812.2MC0604105 Standard Performance Plots

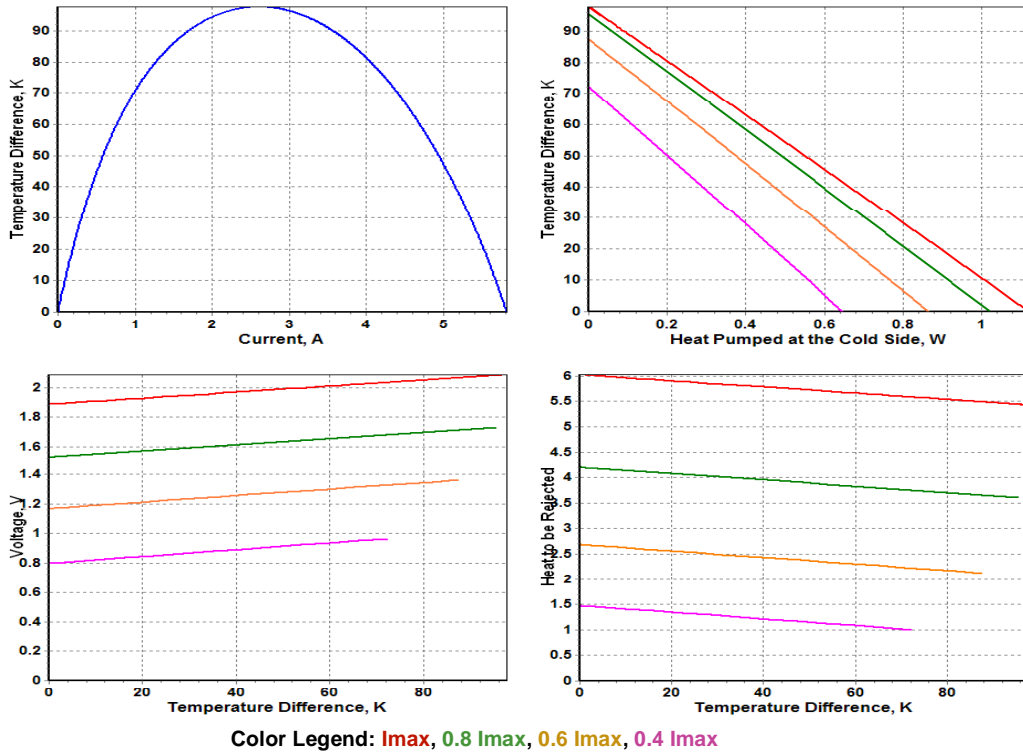

## TO812.2MC0604108 Standard Performance Plots

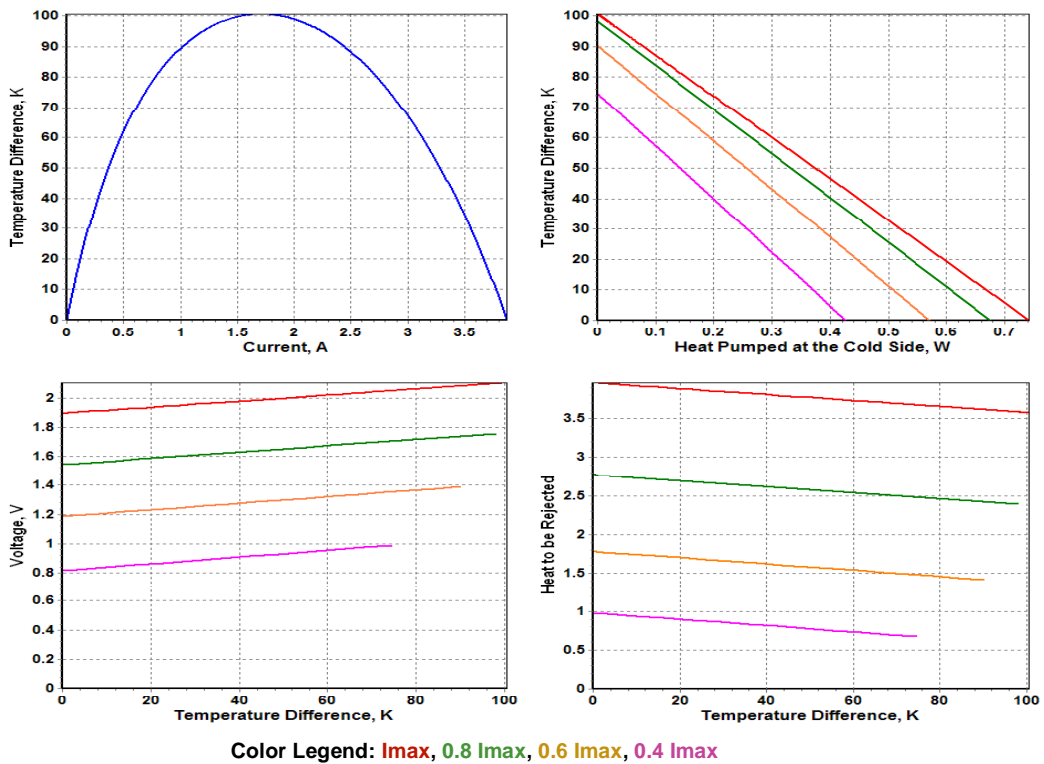

Performance plots are created with TECCAD Software. TECCAD is available for download from RMT Ltd. website - [www.rmtltd.ru](http://www.rmtltd.ru)

# Thermoelectric Sub-mount Datasheet RMT Ltd.

## TO812.2MC0604110 Standard Performance Plots

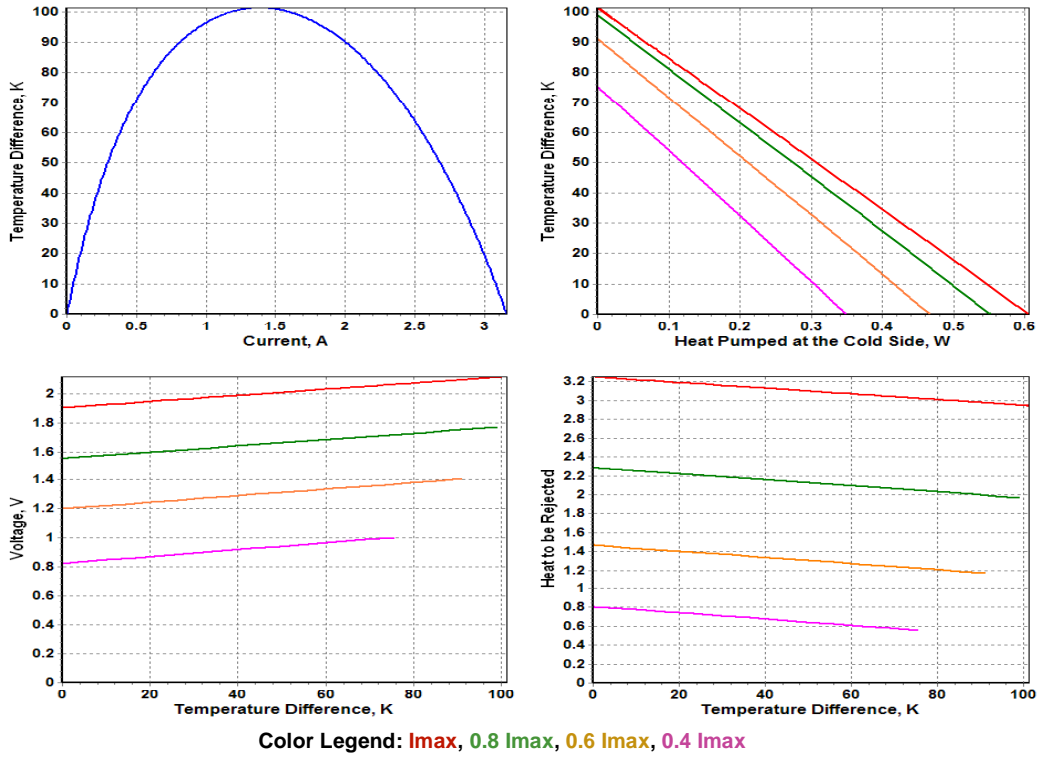

## TO812.2MC0604112 Standard Performance Plots

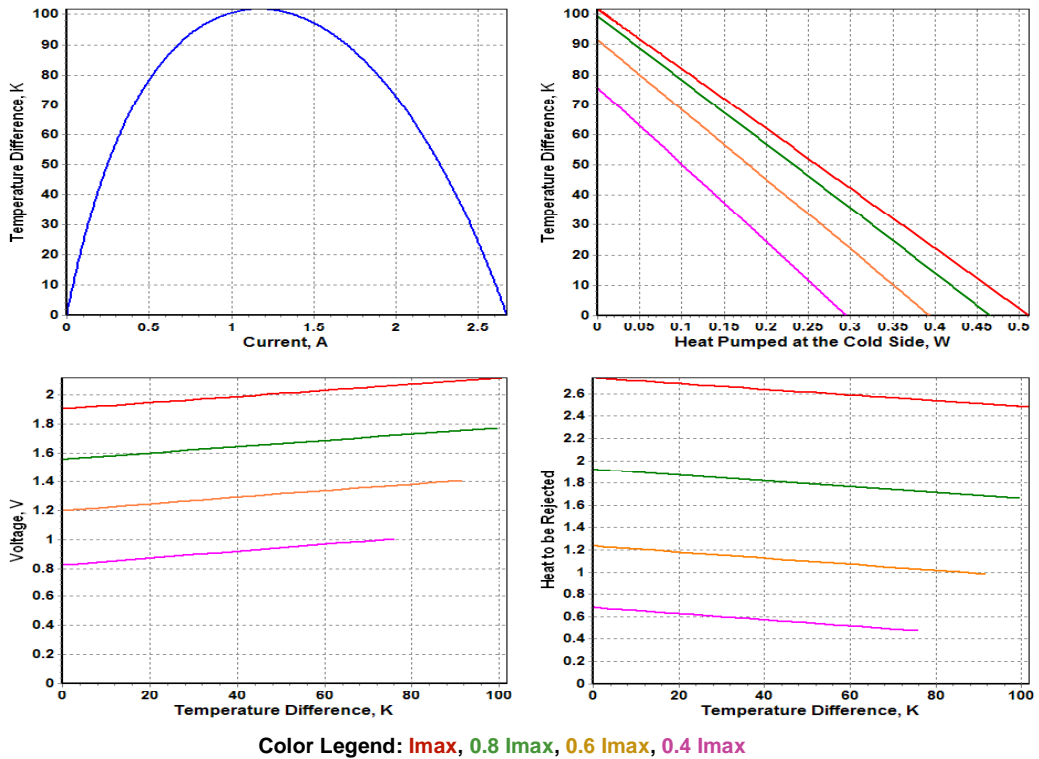

Performance plots are created with TECCAD Software. TECCAD is available for download from RMT Ltd. website - [www.rmtltd.ru](http://www.rmtltd.ru)

Copyright 2007. RMT Ltd. The design and specifications of products can be changed by RMT Ltd. without notice.

# Thermoelectric Sub-mount Datasheet RMT Ltd.

## TO812.2MC0604115 Standard Performance Plots

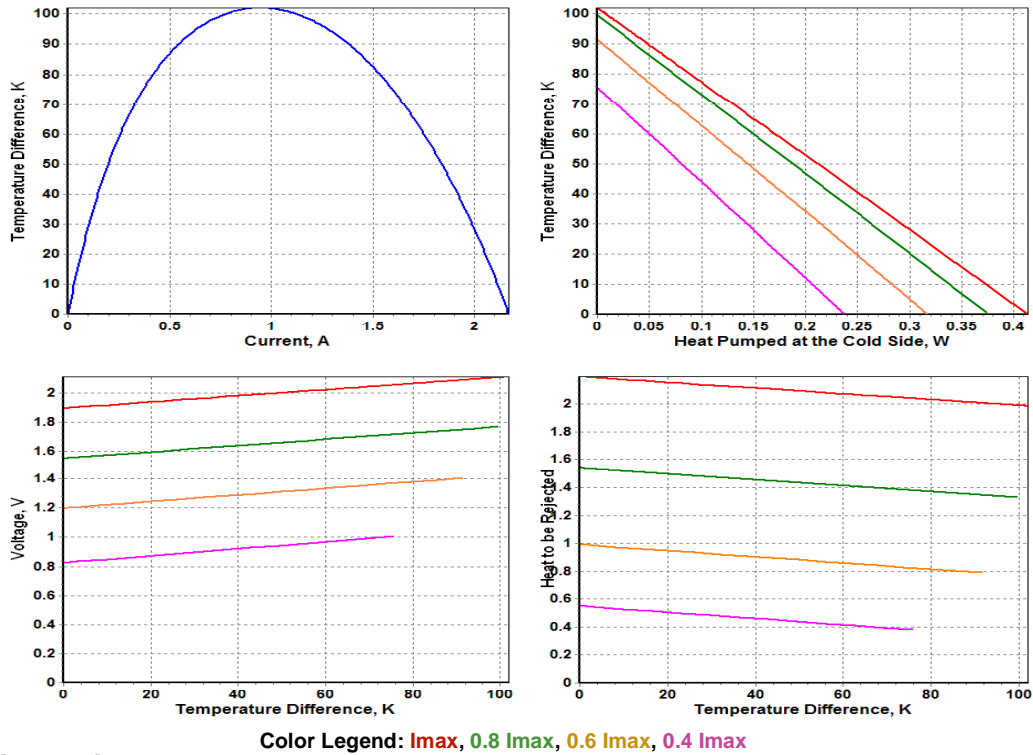

Color Legend: 1.0  $I_{max}$ , 0.8  $I_{max}$ , 0.6  $I_{max}$ , 0.4  $I_{max}$

### Applications Tips

#### Cautions

- Do not heat TE module more than 200°C (TEC assembled at 230°C) or 160°C (TEC assembled at 183°C).
- Do not use TE module without attached heat sink at hot (bottom) side.
- Connect TE sub-mount to a DC power supply in accordance to polarity.
- Do not apply DC current higher than  $I_{max}$ .

#### Installation

- Soldering of object to be cooled.  
Method suitable for a TE module with the metallized cold side (Ordering Options. Item F). Soldering requires careful procedures:
  - Never overheat TEC (Cautions. Item 1).
  - Use solder with melting point less than TEC mounting solder (Ordering Options. Item C).
- Gluing of object to be cooled.  
Method available by glues with good thermoconductive properties. Not recommended for high vacuum applications and long operations at high temperature.

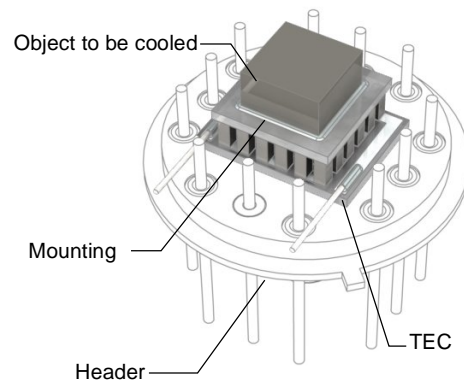

#### Definitions

Value	Description	Notes
$\Delta T_{max}$	Maximum temperature difference at $I=I_{max}$	rated at $Q_{max}=0$ , at other $Q$ it should be estimated as $\Delta T=\Delta T_{max}(1-Q/Q_{max})$
$Q_{max}$	Maximum heat pumping capacity at $I=I_{max}$	rated at $\Delta T=0$ , at other $\Delta T$ it should be estimated as $Q=Q_{max}(1-\Delta T/\Delta T_{max})$
$I_{max}$	Maximum current	Electric parameters resulting in greatest $\Delta T_{max}$
$U_{max}$	Maximum voltage drop	
$R_t$	Header thermal resistance	
-xx	Thermoelectric pellet length code	Pellet length is "-xx" x 10 (in mm)
$T_{hot}$	TEC hot side temperature	Performance data shown in specifications are given for $T_{hot}=300$ K, vacuum
H	Total TEC height	All dimensions are given in mm