

Thermoelectric Sub-mount Datasheet RMT Ltd.

Performance parameters PS28.1MC06070xx

Mounted TEC Type	DT _{max} , K	Q _{max} , W	I _{max} , A	U _{max} , V	R _t , K/W	H, mm
1MC06-070-05	68	15.17	2.98	8.50	0.08	1.6
1MC06-070-08	70	9.96	1.94			1.9
1MC06-070-10	71	8.23	1.57			2.1
1MC06-070-12	71	6.95	1.32			2.3
1MC06-070-15	72	5.65	1.07			2.6

Performance data are given for $T_{hot}=300K$ vacuum

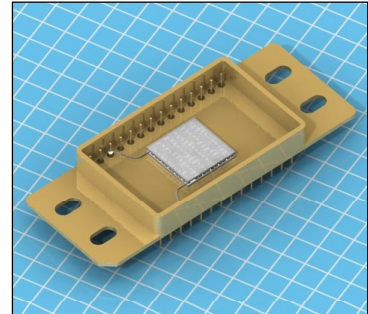

Technical Drawing

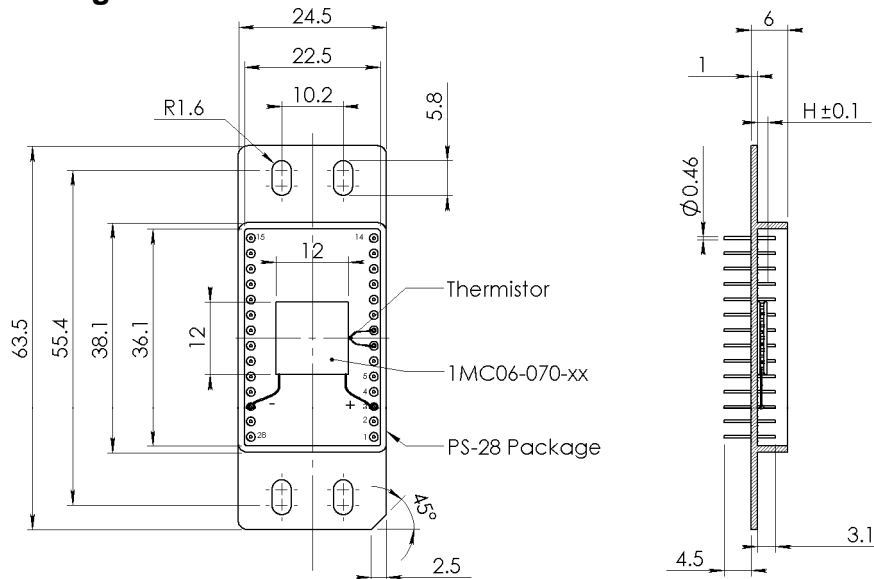

Ordering Options

A. Header material

Kovar

B. Header finish

Gold plating

C. TEC Internal Solder

Solder 230 (SnSb, $T_{melt}=230^{\circ}C$)

D. TEC Mounting

1. Soldering

- 1.1 Solder 199 (SnZn, $T_{melt}=199^{\circ}C$) (used as standard)
- 1.2 Solder 138 (SnBi, $T_{melt}=138^{\circ}C$)
- 1.3 Solder 183 (PbSn, $T_{melt}=183^{\circ}C$)

2. Epoxy gluing

E. TEC Leads Connection

Solder 230 (SnSb, $T_{melt}=230^{\circ}C$)

F. TEC Ceramics

1. Pure Al_2O_3 (100%) - standard
2. Alumina (Al_2O_3 - 96%) - optional
3. Aluminum Nitride (AlN) - optional

G. TEC Cold Side Finish

1. Blank ceramics
2. Metallized
 - 2.1 Ni / Sn(Bi)
 - 2.2 Gold plating
3. Metallized and Pre-tinned
 - 3.1 Solder 94 (PbSnBi, $T_{melt}=94^{\circ}C$)
 - 3.2 Solder 117 (InSn, $T_{melt}=117^{\circ}C$)
 - 3.3 Solder 138 (SnBi, $T_{melt}=138^{\circ}C$)
 - 3.4 Solder 183 (PbSn, $T_{melt}=183^{\circ}C$)
 - 3.5 Solder 199 (SnZn, $T_{melt}=199^{\circ}C$)

H. Thermistor (optional)

NTC thermistor type TB
Resistance nominal
1. 2.2 kOhm@20C
2. 10.0 kOhm@20C

Individual calibration is available in -65..+85°C

I. Thermistor Mounting

Epoxy Gluing

J. Thermistor Leads Connect

Solder 230 (SnSb, $T_{melt}=230^{\circ}C$)

K. Pinout configuration

Can be specified by customer

Thermoelectric Sub-mount Datasheet RMT Ltd.

PS28.1MC0607005 Standard Performance Plots

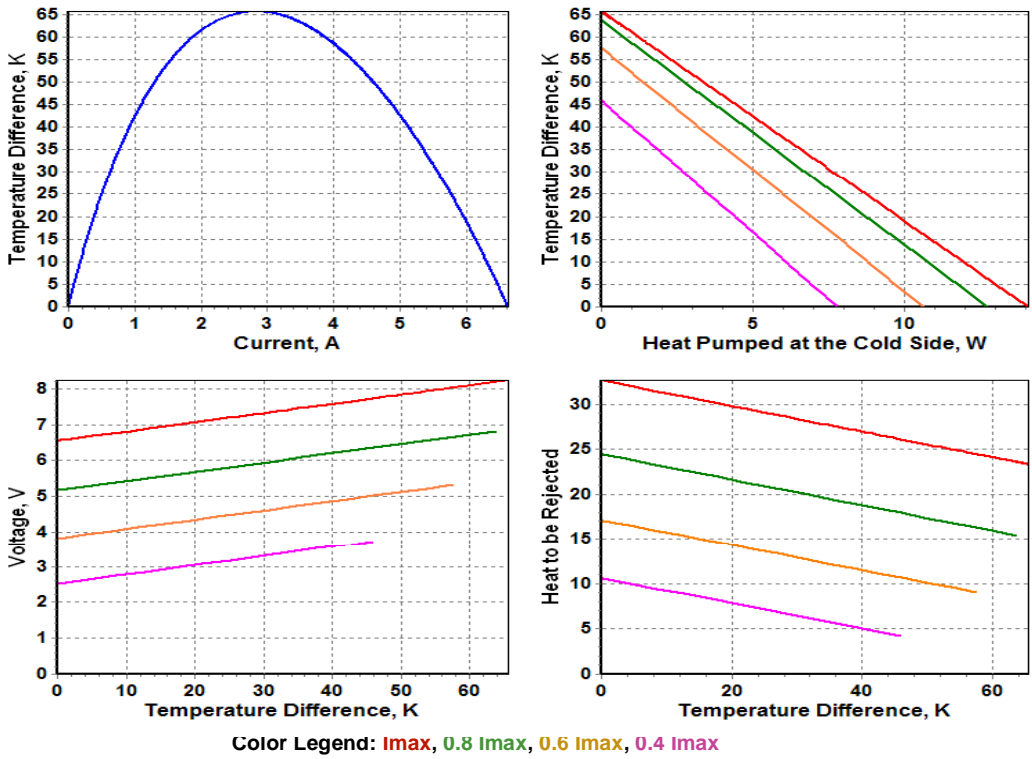

PS28.1MC0607008 Standard Performance Plots

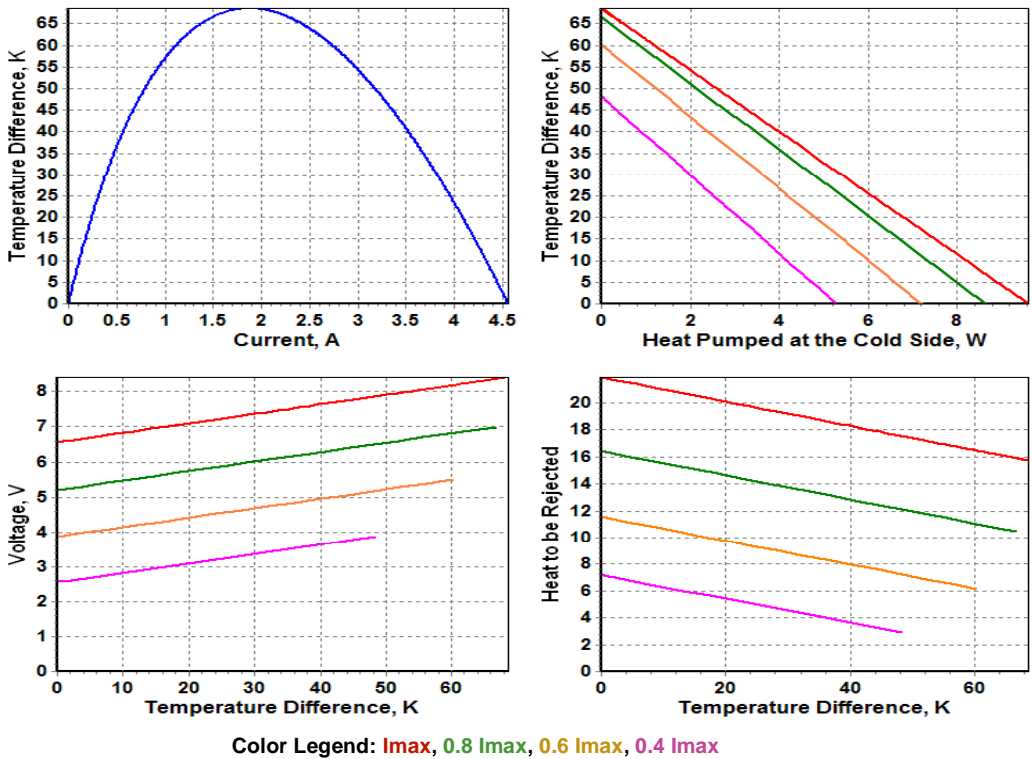

Performance plots are created with TECCAD Software. TECCAD is available for download from RMT Ltd. website - www.rmtltd.ru

Thermoelectric Sub-mount Datasheet ————— *RMT Ltd.*

PS28.1MC0607010 ————— Standard Performance Plots

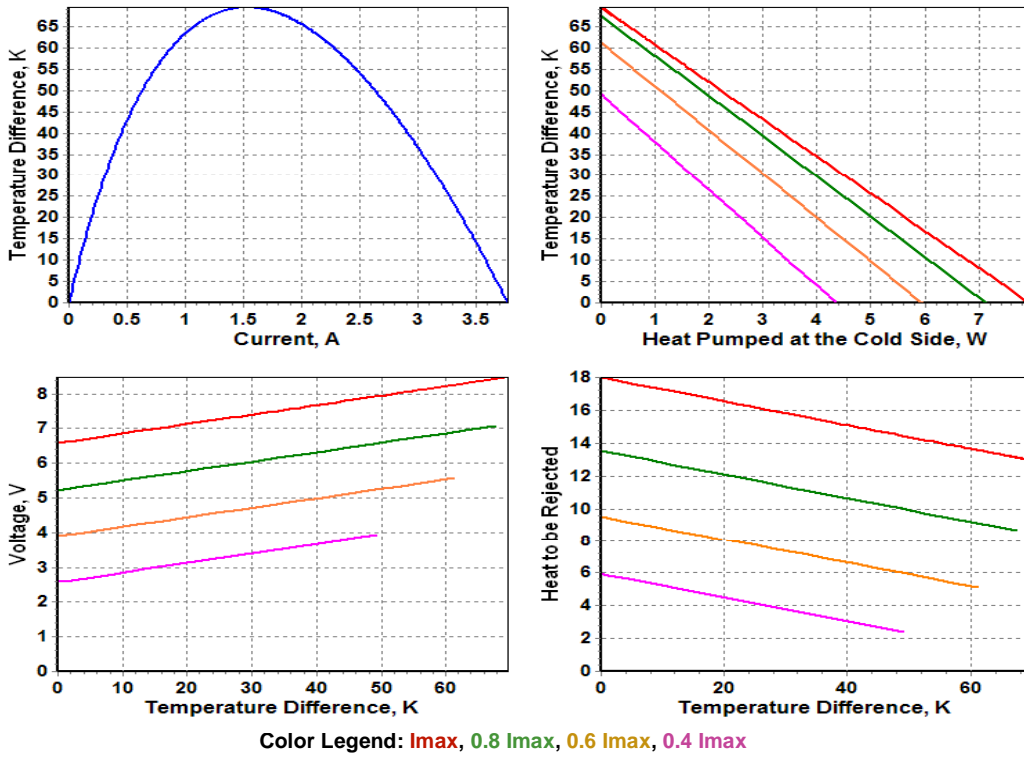

PS28.1MC0607012 ————— Standard Performance Plots

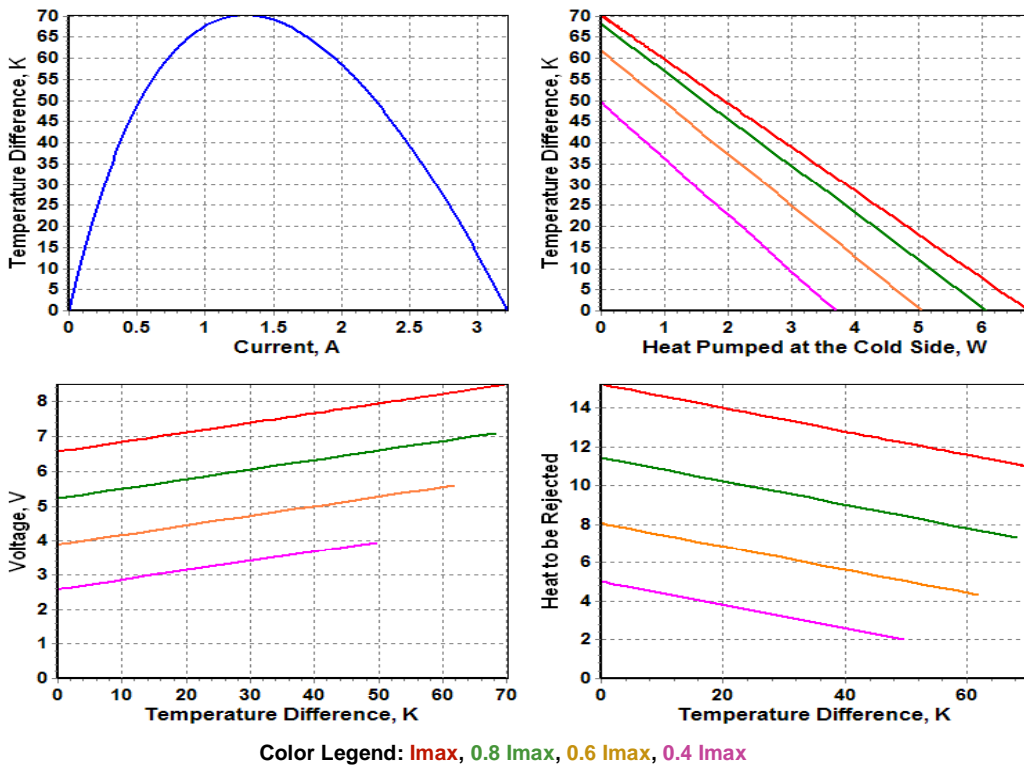

Performance plots are created with TECCAD Software. TECCAD is available for download from RMT Ltd. website - www.rmtltd.ru

Copyright 2007. RMT Ltd. The design and specifications of products can be changed by RMT Ltd. without notice.

PS28.1MC0607015 Standard Performance Plots

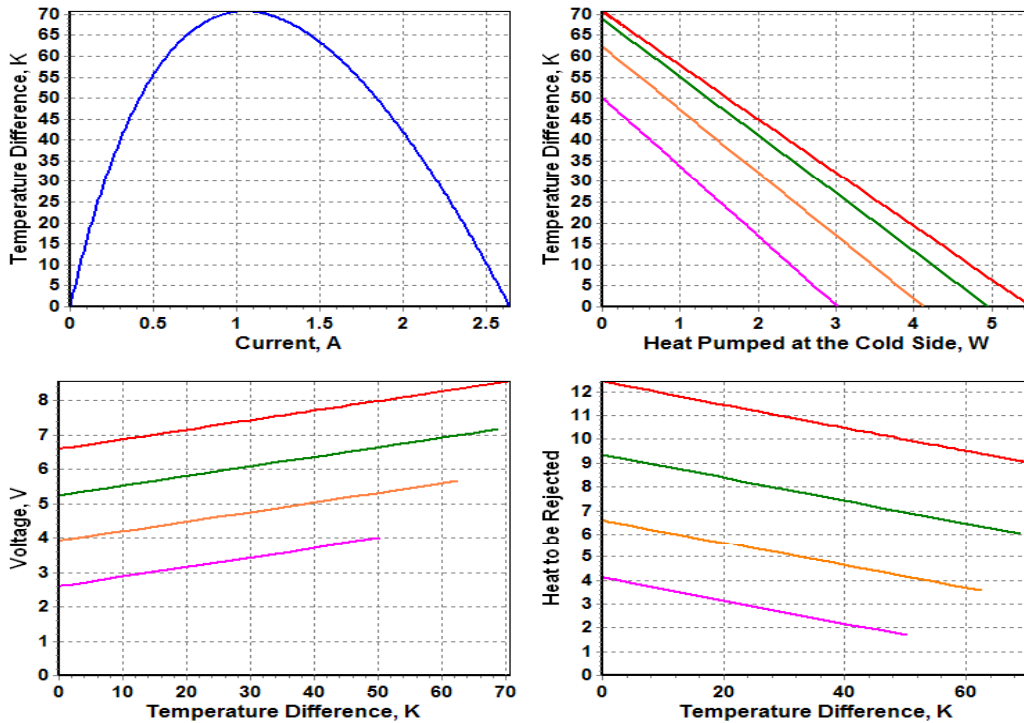

Color Legend: I_{max} , $0.8 I_{max}$, $0.6 I_{max}$, $0.4 I_{max}$

Applications Tips

Cautions

1. Do not heat TE module more than 200°C (TEC assembled at 230°C) or 160°C (TEC assembled at 183°C).
2. Do not use TE module without attached heat sink at hot (bottom) side.
3. Connect TE sub-mount to a DC power supply in accordance to polarity.
4. Do not apply DC current higher than I_{max} .

Installation

1. Soldering of object to be cooled.
Method suitable for a TE module with the metallized cold side (Ordering Options. Item F). Soldering requires careful procedures:
 - A. Never overheat TEC (Cautions. Item 1).
 - B. Use solder with melting point less than TEC mounting solder (Ordering Options. Item C).
2. Gluing of object to be cooled.
Method available by glues with good thermoconductive properties. Not recommended for high vacuum applications and long operations at high temperature.

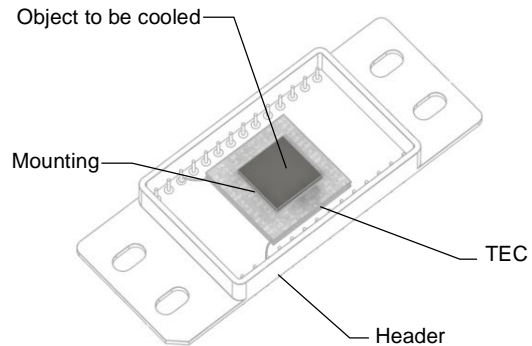

Definitions

Value	Description	Notes
ΔT_{max}	Maximum temperature difference at $I=I_{max}$	rated at $Q_{max}=0$, at other Q it should be estimated as $\Delta T = \Delta T_{max}(1 - Q/Q_{max})$
Q_{max}	Maximum heat pumping capacity at $I=I_{max}$	rated at $\Delta T=0$, at other ΔT it should be estimated as $Q = Q_{max}(1 - \Delta T/\Delta T_{max})$
I_{max}	Maximum current	Electric parameters resulting in greatest ΔT_{max}
U_{max}	Maximum voltage drop	
R_t	Header thermal resistance	
-xx	Thermoelectric pellet length code	Pellet length is "-xx" x 10 (in mm)
T_{hot}	TEC hot side temperature	Performance data shown in specifications are given for $T_{hot}=300$ K, vacuum
H	Total TEC height	All dimensions are given in mm